

Thames Tideway Tunnel
Thames Water Utilities Limited



Application for Development Consent

Application Reference Number: WWO10001

Transport Assessment

Doc Ref: **7.10.18**

King Edward Memorial Park Foreshore

Main Report

APFP Regulations 2009: Regulation **5(2)(q)**

Hard copy available in

Box **52** Folder **B**
January 2013

**Thames
Tideway Tunnel**



Creating a cleaner, healthier River Thames

This page is intentionally blank

Thames Tideway Tunnel

Transport Assessment

Section 21: King Edward Memorial Park Foreshore

List of contents

	Page number
21 King Edward Memorial Park Foreshore	1
21.1 Introduction.....	1
21.2 Proposed development.....	2
21.3 Assessment methodology.....	14
21.4 Baseline.....	19
21.5 Construction assessment	57
21.6 Operational assessment.....	75
21.7 Summary of site-specific TA.....	77
References	80

List of plates

	Page number
Plate 21.2.1 Estimated construction lorry profile.....	6
Plate 21.2.2 Estimated construction barge profile	7
Plate 21.4.1 Thames Path at King Edward Memorial Park riverside	21
Plate 21.4.2 King Edward Memorial Park	21
Plate 21.4.3 Glamis Road towards its junction with The Highway	22
Plate 21.4.4 The Highway looking west at its junction with Glamis Road	23
Plate 21.4.5 CS3 on Cable Street at its junction with Brodlove Lane	24
Plate 21.4.6 Existing traffic flow along Glamis Road (weekday ATC survey)	41
Plate 21.4.7 Existing traffic flow along Cable Street (weekday ATC survey)	42
Plate 21.4.8 Existing traffic flow along Commercial Road (weekday ATC survey) ...	43
Plate 21.4.9 Existing traffic flow along Glamis Road (Saturday ATC survey)	44
Plate 21.4.10 Existing traffic flow along Cable Street (Saturday ATC survey)	45
Plate 21.4.11 Existing traffic flow along Commercial Road (Saturday ATC survey) .	46
Plate 21.4.12 Existing traffic flow along Glamis Road (Sunday ATC survey)	47
Plate 21.4.13 Existing traffic flow along Cable Street (Sunday ATC survey)	48

Plate 21.4.14 Existing traffic flow along Commercial Road (Sunday ATC survey) ... 49
 Plate 21.4.15 On-street parking capacity..... 51

List of tables

	Page number
Table 21.2.1 Construction traffic details	3
Table 21.2.2 Maximum estimated construction worker numbers.....	8
Table 21.2.3 Transport mode split	10
Table 21.2.4 Transport – construction works movements	11
Table 21.4.1 Existing daytime weekday peak hour local bus services and frequencies (number of buses per hour)	26
Table 21.4.2 Existing DLR and London Overground weekday peak hour services and frequencies	28
Table 21.4.3 Existing National Rail weekday peak hour services and frequencies (number of services per hour).....	30
Table 21.4.4 Aggregated frequency (passing craft per hour).....	30
Table 21.4.5 Existing on-street car parking	32
Table 21.4.6 Survey locations	34
Table 21.4.7 Existing pedestrian flows	37
Table 21.4.8 Existing cycle traffic	40
Table 21.4.9 Parking bay availability and usage.....	52
Table 21.4.10 Baseline LinSig model outputs.....	54
Table 21.4.11 Accident severity from 2006 to 2011.....	56
Table 21.5.1 Construction base case LinSig model outputs.....	60
Table 21.5.2 Estimated maximum delay for bus services.....	64
Table 21.5.3 Construction development case LinSig model outputs (AM peak hour)	69
Table 21.5.4 Construction development case LinSig model outputs (PM peak hour)	70
Table 21.5.5 King Edward Memorial Park Foreshore site design measures	71
Table 21.5.6 Sensitivity testing LinSig model outputs (AM peak hour)	73
Table 21.5.7 Sensitivity testing case LinSig model outputs (PM peak hour)	74
Table 21.7.1 King Edward Memorial Park Foreshore Transport Assessment results	78

21 King Edward Memorial Park Foreshore

21.1 Introduction

- 21.1.1 This site specific *Transport Assessment (TA)* presents the findings of the assessment of the transport issues of the Thames Tideway Tunnel project at the King Edward Memorial Park Foreshore site located within the London Borough (LB) of Tower Hamlets.
- 21.1.2 The assessment takes into consideration the changes as a result of all other Thames Tideway Tunnel sites to ensure that results indicate the significance of each individual site in combination with construction works being undertaken at other sites.
- 21.1.3 The purpose of this *TA* is to identify the site context, development proposals and any transport implications arising from these proposals to ensure that appropriate mitigation measures are identified, where necessary.
- 21.1.4 The *Transport Assessment* draws on a number of project-wide or common documents which include the Transport Strategy and the *Code of Construction Practice (CoCP)*ⁱ. Further detail on these documents which form the background to the *Transport Assessment* can be found in Section 1 of the *TA*
- 21.1.5 The *TA* structure is as follows:
- a. Section 21.2 includes a description of the proposed development, detailing construction phasing, vehicle and person trip generation and construction traffic routing. It also provides details of the operational phase.
 - b. Section 21.3 outlines the assessment methodology used for the *TA* for the construction and operational phases.
 - c. Section 21.4 details the baseline conditions on the transport network surrounding the site, including survey data analysis and accident analysis.
 - d. Section 21.5 provides the assessment of the construction phase of the project, including a comparison between the construction base case and the construction development case. This section also outlines sensitivity testing for the highway network.
 - e. Section 21.6 provides the assessment of the operational phase of the project.
 - f. Section 21.7 summarises the *TA* findings.

ⁱ The *Code of Construction Practice (CoCP)* is provided in Vol 1 Appendix A of the *Environmental Statement*. It contains general requirements (Part A), and site specific requirements for this site (Part B).

21.2 Proposed development

21.2.1 The proposed development site is located within the LB of Tower Hamlets and would occupy an area of the river Thames foreshore and a portion of King Edward Memorial Park, south of The Highway (A1203). The construction area would be 2ha. The permanent works would include a 0.2ha foreshore reclamation which would then form part of the King Edward Memorial Park. Figure 21.2.1 in the King Edward Memorial Park Foreshore *Transport Assessment* figures indicates the site location.

Construction

- 21.2.2 The site is located within the river Thames foreshore. The land to the north of the site is King Edward Memorial Park, which is bounded north by The Highway (A1203) and by Glamis Road to the west. The construction site would be accessed from an existing access point on Glamis Road to the west of King Edward Memorial Park, which would operate on a left-turn in, right-turn out arrangement for construction vehicles.
- 21.2.3 Construction at the site is anticipated to last for three and a half years. Early works, such as utility connections and diversions may be undertaken in advance of the main works.
- 21.2.4 There would be four phases of construction; phase 1 - site set-up, phases two and three for shaft construction and the construction of other structures, and phase 4 for site demobilisation. The access plan and highway layout during construction phases plan within the King Edward Memorial Park Foreshore *Transport Assessment* figures, presents the highway layout during construction. This layout is the same for all three phases of construction.
- 21.2.5 Stage 1 *Road Safety Audits* have been carried out on the illustrative highway layouts proposed for this site. The *Road Safety Audit* reports for this site are contained in Section 21 Appendix E.
- 21.2.6 During construction it is anticipated that the transport networks may be affected as a result of the additional construction traffic associated with this site, pedestrian and cycle diversions in the vicinity and changes to car parking in the area.
- 21.2.7 The cycle advance area and stop line on Glamis Road on the northbound arm of the junction with The Highway (A1203) would need to be relocated further south to enable large vehicles to left-turn into Glamis Road from The Highway without conflict with cyclists or vehicles at the stop line.
- 21.2.8 Vehicle access to and from the site would take place via a new permanent vehicle route between Glamis Road and the site through the southern end of the playing field, tennis court and the Park.
- 21.2.9 The Thames Path routes along the riverside footway, part of which would be occupied by the construction site and access road during construction, and would therefore require diversion during the construction period. During the daytime a controlled crossing north of the existing Rotherhithe Tunnel ventilation shaft will allow Thames Path users to continue to follow the Thames Path south of the new access road to Glamis Road unless

construction vehicles are approaching on the access road. This controlled crossing is to be manned by appropriate staff throughout the day. When construction vehicles are using the route, Thames Path users would be diverted to the north-western corner of the King Edward Memorial Park where they can access Glamis Road via an existing access. From here the diversion would lead south along the eastern footway of Glamis Road to re-join the existing Thames Path route at the site access.

- 21.2.10 To accommodate the movement of larger construction vehicles into and out of the site it would be necessary to suspend 15m of car parking on Glamis Road. This parking would not be re-provided.
- 21.2.11 There would be a gated access for the left-turn in / right-turn out movement at the site access. The existing access would be widened to accommodate HGVs and dropped kerbs and tactile paving would be provided for pedestrians.
- 21.2.12 Parking for five essential maintenance vehicles would be provided on site. No worker parking would be provided.
- 21.2.13 During construction 90% of the cofferdams fill (both import and export) and 90% of the excavated material from the shaft would be transported by barge and all other material by road.
- 21.2.14 A summary of the construction lorry and barge movement details for the site is presented in Table 21.2.1.

Table 21.2.1 Construction traffic details

Description	Assumption
Assumed peak period of construction lorry movements	Site Year 1 of construction
Assumed average peak daily construction lorry vehicle movements (in peak month of Site Year 1 of construction)	82 movements per day (41 vehicle trips)
Assumed peak period of construction barge movements	Site Year 3 of construction
Assumed average peak daily construction barge movements (in peak month of Site Year 3 of construction)	4 movements per day (2 barge trips)
Typical types of lorry requiring access (comprising rigid-bodied, flatbed and articulated vehicles)	Excavation lorries Temporary construction material lorries Ready Mix Concrete lorries Plant and equipment lorries Steel Reinforcement lorries Imported fill lorries Office / general delivery lorries Grout/materials lorries

Note: a movement is a construction vehicle moving either to or from the site. A Site Year is a 12 month period, one in a series of Site Years; Site Year 1 commences at the start of construction

Construction routes

- 21.2.15 The access plan and highway layout during construction phases plans in the King Edward Memorial Park Foreshore *Transport Assessment* figures show the highway layout during construction.
- 21.2.16 Figure 21.2.2. in the King Edward Memorial Park Foreshore *Transport Assessment* figures shows the construction routes for Falconbrook Pumping Station. The Construction routes have been discussed with both Transport for London (TfL) and the Local Highway Authority, the LB of Tower Hamlets.
- 21.2.17 The site would be accessed from Glamis Road, a local road that connects to The Highway (A1203) at a signalised junction. The Highway (A1203) forms part of the Transport for London Road Network (TLRN). The northern end of Glamis Road is included within the LLAU (the full site boundary) to enable junction modifications and utilities diversions.
- 21.2.18 The main junctions along the construction traffic routes are:
- 21.2.19 Glamis Road / The Highway (A1203)
- The Highway (A1203) / Butcher Row (A216)
 - Butcher Row (A216) / Commercial Road (A13).
- 21.2.20 The construction routing for all phases at the King Edward Memorial Park Foreshore site would use the TLRN, approaching the site from the direction of Commercial Road (A13) and Butcher Row to the northeast. Vehicles departing would return in the same direction. Vehicle access would be arranged on a 'left-turn in, right-turn out' only basis. All vehicles would arrive at and depart from the site via the junction with Glamis Road / The Highway (A1203).
- 21.2.21 The exact routing of construction traffic depends on the origins and destinations of construction materials which are detailed in the *Project-wide TA* (contained within Section 3).

Proposed construction flows

Construction vehicles and barges

- 21.2.22 Proposed working hours are set out in the *CoCP* and vehicle movements would take place during the standard day shift of ten hours on weekdays (08:00 to 18:00) and five hours on Saturdays (08:00 to 13:00). In exceptional circumstances HGV and abnormal load movements could occur up to 22:00 on weekdays for large concrete pours and later at night on agreement with the LB of Tower Hamlets.
- 21.2.23 A site-specific peak construction assessment year has been identified. The histograms in Plate 21.2.1 and Plate 21.2.2 show that the peak site-specific activity at the site would occur in Site Year 1 of construction. This site-specific peak is before the overall project-wide construction peak activity year of 2019.

- 21.2.24 This *TA* assesses this site-specific peak construction year. As detailed in Table 21.2.1, there would be 82 average peak daily construction lorry vehicle movements and an estimated four peak daily construction barge movements. The number of vehicular movements will vary throughout the construction period, and the histogram in Plate 21.2.1 shows the construction vehicle profile during construction.
- 21.2.25 The assessment is based on 10% of the daily number of lorry journeys occurring in the peak hours, which has been agreed with TfL as a reasonable approach. It is recognised that it may be desirable to reduce the number of construction lorry movements in peak hours and the mechanisms for addressing this would form part of the *Traffic Management Plans (TMP)* which are required as part of the *CoCP*.

Plate 21.2.1 Estimated construction lorry profile

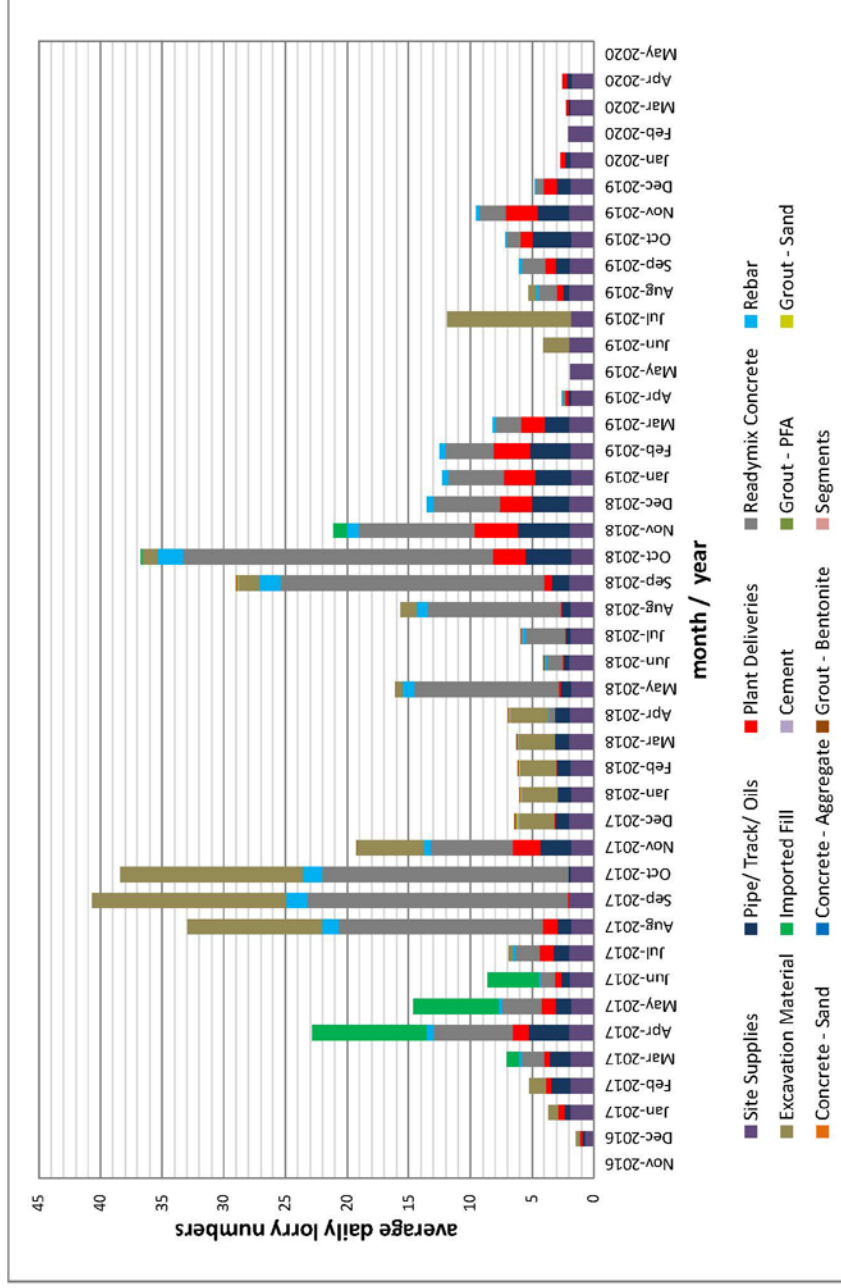

Note: Figure shows approximate volumes and number of vehicle trips based upon assumed timings for the works. It is not a programme and remains subject to change.

Plate 21.2.2 Estimated construction barge profile

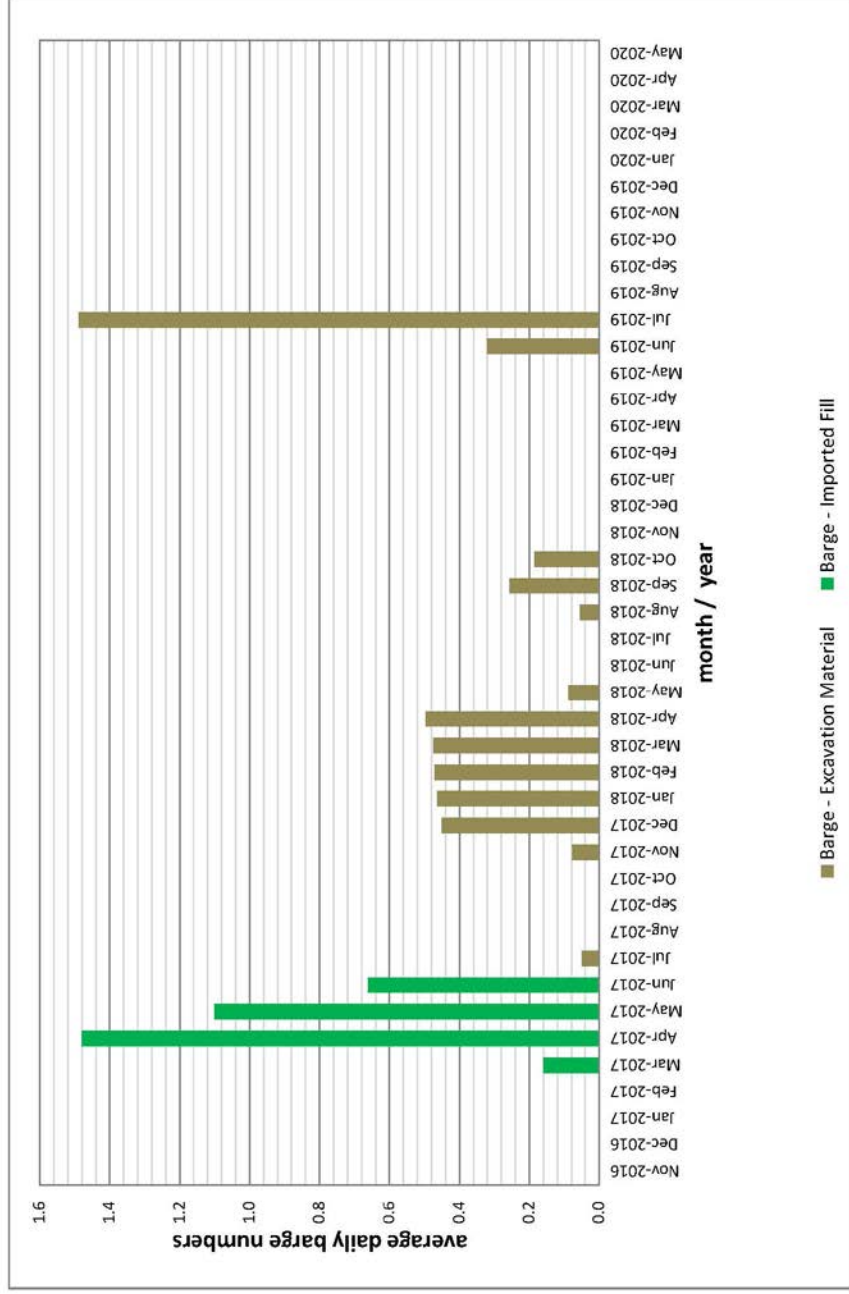

Note: Figure shows approximate volumes and number of barge trips based upon assumed timings for the works. It is not a programme and remains subject to change.

- 21.2.26 As the *Project-wide Transport Assessment* explains, the TfL Highway Assignment Models (HAMs) used for the strategic highway modelling represent peak hours of 08:00 to 09:00 and 17:00 to 18:00 and these have been taken as being the network-wide AM and PM peak hours in the project-wide and site-specific assessments.
- 21.2.27 The 07:00 to 09:00 and 17:00 to 19:00 periods identified from the local traffic surveys are busier on the network in the weekday than those encountered at the weekends (this is discussed in Section 21.4). Whilst the AM and PM peak hours differ slightly from these network-wide peak hours, in practice the number of vehicle movements at this site would be low in comparison to base case traffic flows on the adjacent network and is expected to be constant throughout the day.
- 21.2.28 Hourly construction vehicle trips during the inter-peak period are not expected to exceed the hourly trips assumed for the 08:00 to 09:00 and 17:00 to 18:00 periods used in this assessment. The peak travel periods used for the modelling in this assessment are therefore the weekday periods between 08:00 and 09:00 and 17:00 and 18:00.
- 21.2.29 Plate 21.2.1 and Plate 21.2.2 indicate the construction vehicle and construction barge profiles during construction, the number of vehicular movements would vary throughout the construction period, with over 16 months with less than 30 HGV movements a day and three months with over 66 movements a day during the three and half year build programme.
- 21.2.30 Other construction vehicle movements associated with site operations and contractor activities would be cars and light goods vehicles. The construction worker vehicle movements expected to be generated by the King Edward Memorial Park Foreshore site is summarised in Table 21.2.2.

Construction workers

- 21.2.31 The construction site is expected to require a maximum workforce of approximately 40 workers at any one time. The number and type of workers is shown in Table 21.2.2

Table 21.2.2 Maximum estimated construction worker numbers

Contractor		Client
Staff*	Labour**	Staff***
08:00-18:00	08:00-18:00	08:00-18:00
15	20	5

* Contractor Staff – engineering and support staff brought in to project manage the engineering work and site.

*** Labour – those working on site doing engineering, construction and manual work. *** Client Staff – engineering and support staff managing the project and supervising the Contractor*

- 21.2.32 Whilst the 2001 Censusⁱⁱ journey to work data for the King Edward Memorial Park area shows that the predominant mode of travel is by car, it is considered unlikely that any workers would travel to or from the site by car as there would be no parking provided within the site boundary for workers, parking on surrounding streets is also restricted, and measures to reduce car use would be incorporated into a site-specific *Travel Plan*.
- 21.2.33 As indicated in Table 21.2.3, the predominant mode of travel for journeys to work in this area is likely to be by London Overground, National Rail and Docklands Light Railway (DLR) stations. It is assumed that the directions to and from the site would be from the nearest London Overground, National Rail, DLR stations which are:
- 21.2.34 Shadwell DLR station approximately 700m walking distance or nine minutes walking time to the northwest of the site
- 21.2.35 Wapping Rail Station, which is approximately 650m walking distance or over eight minutes walking time to the southwest of the site
- 21.2.36 Limehouse National Rail station which is approximately 1km walking distance or 12 minutes walking time to the north-east of the site.
- 21.2.37 The Census mode shares have therefore been adjusted to reflect increased levels of non-car use by workers at this site. This mode split is outlined in Table 21.2.3. The mode split outlined in Table 21.2.3 has therefore been used to assess the impacts of worker journeys on the highway and public transport networks.

ⁱⁱ Based on 2001 Census. This type of data had not been released from the 2011 Census at the time of the assessment.

Table 21.2.3 Transport mode split

Mode	Percentage of trips to site	Equivalent number of worker trips (based on 40 worker trips)	
		AM peak hour (07:00-8:00)	PM peak hour (18:00-19:00)
Bus	8%	3	3
National Rail / London Overground	42%	17	17
Tube	0	0	0
DLR	34%	14	14
Car driver	<1%*	0	0
Car passenger	<1%*	0	0
Cycle	3%	1	1
Walk	10%	4	4
River	0%	0	0
Other (taxi/motorcycle)	3%	1	1
Total	100%	40	40

* Assumed to be zero for the purpose of this assessment

21.2.38 As indicated in Table 21.2.3 it is assumed that the predominant mode of travel for journeys to work in this area is public transport and it is assumed that the directions to and from the site would be along Glamis Road and The Highway to the nearest bus stops to the north and west of the site as well as to Shadwell DLR and London Overground station to the northwest and to Limehouse DLR and Rail station to the northeast of the site.

21.2.39 It is difficult to predict with certainty the directions to and from which workers at the site would travel. Staff could potentially be based in the local area or in the wider Greater London area and are unlikely to have the same trip attraction to primary A roads as construction lorries.

Vehicle movement summary

21.2.40 The total anticipated number of construction-related vehicle movements in the peak month of activity at this site is set out in Table 21.2.4.

Table 21.2.4 Transport – construction works movements

Vehicle type	Vehicle movements per time period				
	Total daily	0700 to 0800	0800 to 0900	1700 to 1800	1800 to 1900
Construction lorry vehicle movements 10%*	82	0	8	8	0
Other construction vehicle movements**	36	0	4	4	0
Worker vehicle movements***	nominal	0	0	0	0
Total	118	0	12	12	0

* The assessment is based on 10% of the daily construction lorry movements associated with materials taking place in each of the peak hours.

** Other construction vehicle movements includes cars and light goods vehicles associated with site operations and contractor activity.

*** Worker vehicle numbers are based on less than 1% of workers driving, on the basis that there would be no worker parking on site, on-street parking in the area is restricted, and site-specific Travel Plan measures would discourage workers from driving by car. In practical terms, this would be close to zero.

- 21.2.41 To ensure the assessment of the highway network is robust it has been based on a combination of the peak hour of movements for construction lorries and other construction vehicles between 07:00 and 09:00 and 17:00 and 19:00. These have been combined and applied to the peak hour to take into account the highest number of movements generated by the site.
- 21.2.42 An average peak flow of 118 vehicle movements a day is expected during the months of greatest activity during Site Year 1 of construction at this site.
- 21.2.43 At other times in the construction period Table 21.2.4 shows that in the AM and PM peak periods, the King Edward Memorial Park Foreshore site would generate approximately 12 vehicle movements per peak period.

Code of Construction Practice

- 21.2.44 Measures incorporated into the *Code of construction practice (CoCP)*ⁱⁱⁱ Part A (Section 5) to reduce transport impacts include:
 - a. site specific *Traffic management plans (TMP)*: to set out how vehicular access to the site would be managed so as to minimise impact on the local area and communicate this with

ⁱⁱⁱ The *Code of Construction Practice (CoCP)* is provided in Vol 1 Appendix A. It contains general requirements (Part A), and site specific requirements for this site (Part B).

the local borough and other stakeholders. This includes any works on the highway, diversion or temporary closure of the highway, diversion or temporary closure or public right of way.

- b. HGV management and control: to ensure construction vehicles use appropriate routes to the sites and the vehicle fleet and/or drivers meet current safety and environmental standards.
- c. site specific *River transport management plans (RTMP)* are to be produced for each relevant worksite. As with the *TMP*'s this would set out how river access to site would be managed so as to minimise impact on the river and communicate this with the PLA, local borough and other stakeholders.

21.2.45 In addition to the general measures within the *CoCP Part A* (Section 5) the following measures have been incorporated into the *CoCP Part B* (Section 5):

- a. the site access would be only via Glamis Road from The Highway (A1203). Access to the site would be from the north with left turn into the site and right turn out
- b. the security barrier would be positioned to allow a standard rigid tipper vehicle to be wholly off the road whilst awaiting barrier operation
- c. a gated crossing would be provided in King Edward Memorial Park to enable the realigned Thames Path to cross the new access road. The gates would only be closed during vehicle movements. A traffic marshal would be deployed to ensure the safe movement of vehicles and public crossing
- d. the new site access road to the east of the existing playground between the football pitch/maintenance area and the foreshore would be a single lane only with appropriate traffic control
- e. areas of parking suspension would be confirmed with the LB of Tower Hamlets
- f. adequate advance notice and signage would be provided for the diversion of the Thames Path.

21.2.46 The effective implementation of the *CoCP Part A* and *Part B* measures is assumed within the assessment.

21.2.47 Based on current travel planning guidance including TfL's 'Travel planning for new development in London (TfL, 2011)¹' this development lies within the threshold for producing a Strategic Framework Travel Plan. A *Draft Project Framework Travel Plan* has been prepared based on the TfL ATTrBuTE guidance²; this is submitted as part of the application documentation. The *Draft Project Framework Travel Plan* addresses project-wide travel planning measures, including the need for a Travel Plan Manager, initial travel surveys during construction and a monitoring framework. It also contains requirements and guidelines for the site-specific travel plans to be prepared by the site contractors.

The site-specific travel-planning requirements of relevance to the *Draft Project Framework Travel Plan* are as follows:

- a. information on existing transport networks and travel initiatives for the King Edward Memorial Park Foreshore site
- b. a mode split established for the King Edward Memorial Park Foreshore site construction workers to establish and monitor travel patterns
- c. site-specific targets and interim targets based on the mode share which would link to objectives based on local, regional and national policy
- d. a nominated person with responsibility for managing the Travel Plan monitoring and action plans specifically for this site.

Other measures during construction

- 21.2.48 The embedded design measures not outlined in the *CoCP* but which is of relevance to the *Transport Assessment* at the King Edward Memorial Park Foreshore site comprises:
- a. relocation of the stop line and advanced cycle stop line on the southern Glamis Road arm of the Glamis Road / The Highway (A1203) signalised junction
 - b. removal of the footway at the crossover of the two new site access on Glamis Road
- 21.2.49 This measure is detailed further within Section 21.5 construction assessment.

Operation

- 21.2.50 In the operational phase the car parking suspended during construction would be reinstated to the existing layout.
- 21.2.51 The site would be accessed from Glamis Road for maintenance visits. The site access crossover constructed for the construction phase would be retain but modified to create a shorter crossing distance for pedestrians.
- 21.2.52 During operation it is anticipated that there would be no significant issues for the transport infrastructure and operation within the local area because maintenance trips to the site will be infrequent and short term. On this basis the only elements considered in the operational phase assessment are:
- a. car parking
 - b. highway layout and operation.
- 21.2.53 The potential for operational impacts on highway layout and operation is due to the short-term effects of the physical aspects of access to the site for maintenance. These have only been considered qualitatively because the changes required to the highway network during maintenance activity would be minor and temporary, meaning that a quantitative assessment is not required.

The scope of this analysis has been discussed with the LB of Tower Hamlets and TfL.

- 21.2.54 Access would be required for a light commercial vehicle on a three-to six-monthly maintenance schedule.
- 21.2.55 Additionally there would be more substantive maintenance visits at approximately ten year intervals requiring access to enable two mobile cranes and associated support vehicles to be brought to the site, which may require temporary suspension of on-street parking in the vicinity of the site access. The cranes would facilitate lowering and recovery of tunnel inspection vehicles and to provide duty/standby access for personnel.
- 21.2.56 During operation, maintenance vehicles would enter the site from Glamis Road. The highway layout during operation plans are provided in the King Edward Memorial Park Foreshore *Transport Assessment* figures and indicate the operational layout at the site.

21.3 Assessment methodology

Engagement

- 21.3.1 An extensive scoping and technical engagement process has been undertaken. All consultee comments relevant to this site are presented in Volume 21 of the *Environmental Statement*. The *TA* examines the operational phase in order to satisfy the relevant stakeholders that technical issues have been addressed (for example, those associated with access for maintenance activities).
- 21.3.2 Whilst the effects associated with transport for the operational phase have been scoped out of the *Environmental Statement*, the *Transport Assessment* examines the operational phase in order to satisfy the relevant stakeholders that technical issues have been addressed (for example, those associated with access for maintenance activities).

Consultees

- 21.3.3 Throughout the scoping and technical engagement process, the key stakeholders with regards to transport, primarily TfL and the relevant local borough for each site, have been consulted. For this site, the LB of Tower Hamlets has been consulted and the comments which have arisen relating directly to the site have been recorded and responded to accordingly.
- 21.3.4 The key comments arising from the stakeholder engagement are:
- a. the Council is opposed to the selection of the King Edward Memorial Park foreshore option as the preferred site
 - b. the plans showing the future access across the Park to the completed machinery and shaft at the foreshore are not very detailed, and concerns are that it will run parallel to the old route of the Council maintained footpath from Glamis Road to

the existing listed shaft in the park leading down to the Rotherhithe Tunnel

- c. on-street parking in Glamis Road up to the point of access would most likely need to be suspended
- d. physical changes to The Highway/Glamis Road junction and more traffic on the junction will prevent free-flow of traffic on Glamis Road
- e. clarification is required of whether materials associated with construction of connection tunnels and chambers will be included within the assessment of each construction site
- f. an appropriate computer based road traffic modelling package should be agreed with the LB of Tower Hamlets Highways Team
- g. clarification on the number of lorry and barge movements is needed
- h. the interaction of construction traffic with existing traffic on The Highway will cause congestion throughout the day. The need for lorries to make right turns from Glamis Road into The Highway would mean additional delays to traffic on The Highway are likely, particularly if vehicles are blocking traffic while they are queuing to turn
- i. consider reconfiguration of Glamis Road arm of junction with The Highway so that construction vehicles left-turning into Glamis Road do not conflict with vehicles queuing at the stop line
- j. the impact of construction vehicles on the bus services and facilities on Glamis Road must be investigated
- k. the impact of construction vehicles on the parking bays on Glamis Road must be investigated
- l. the possibility of achieving operational access by river should be investigated
- m. use of Limehouse Link and/or Blackwall Tunnel as HGV routes may not be possible due to height / weight restrictions. Use of A13 would be preferred route for HGVs.

21.3.5 The key technical issues raised have been addressed as far as is practicable at this stage within this *TA*, *Project-wide TA* and the *Environmental Statement*, in consultation with both TfL and the LB of Tower Hamlets.

Construction

21.3.6 The assessment methodology for the construction phase follows that described in the *Project-wide TA*. There are no site specific variations for undertaking the construction assessment of this site.

Construction assessment area

- 21.3.7 The assessment area for the King Edward Memorial Park Foreshore site includes the proposed site access directly from Glamis Road and the signalised junction of Glamis Road with The Highway (A1203).
- 21.3.8 These roads and junctions have been assessed for highway, cycle and pedestrian impacts. The Thames Path has been included within the assessment as its current daytime route would need to be diverted around the proposed development site.
- 21.3.9 Effects on local bus services within 640m of the site and rail services within 960m of the site have also been assessed. The Public Transport Accessibility Level (PTAL) of the site, calculated using TfL's approved PTAL methodology assumes a walking speed of 4.8km/h and considers rail stations within a 12 minute walk (960m) of the site and bus stops within an eight minute walk (640m).
- 21.3.10 The extent of the assessment area for the local highway network modelling has been informed by considering the volume of construction traffic at this site and the degree of impact that would be experienced at the nearest junction of the construction vehicle route with the SRN or TLRN. Where the assessment shows that the forecast impacts at this junction would not be significant, junctions further afield on the strategic network have not been assessed. Where impacts are forecast to be significant, a wider area of the local network has been considered in the assessment
- 21.3.11 The assessment for this site takes account of construction vehicle movements associated with the site together with construction traffic from other Thames Tideway Tunnel sites that would use the highway network in the vicinity of this site in Site Year 1 of construction at the King Edward Memorial Park Foreshore site.

Construction assessment year

- 21.3.12 To assess the busiest case scenario for the site locality, the peak construction traffic year has been identified. This ensures that the assessment year for the King Edward Memorial Park Foreshore site takes into consideration the heaviest flow of construction vehicles at this site on local roads for the local modelling assessment.
- 21.3.13 The site-specific peak construction traffic year at King Edward Memorial Park Foreshore site is Site Year 1 of construction.
- 21.3.14 The assessment of the aggregated Thames Tideway Tunnel construction traffic flows on the wider highway network is included within the *Project-wide TA*.

Highway network modelling

- 21.3.15 The assessment for each site takes account of construction vehicle movements associated with the site together with construction

traffic from other Thames Tideway Tunnel project sites that would use the highway network in the vicinity of this site in Site Year 1 of construction.

- 21.3.16 As indicated in the *Project-wide TA*, the TfL HAMs have been used as part of the assessment. The strategic highway modelling has used three of the HAMs, which cover west, central and east London. These three models cover the locations of all of the Thames Tideway Tunnel project sites and this approach has been agreed with TfL.
- 21.3.17 The HAMs have been developed by TfL using GLA employment and population forecasts, which are based on the employment and housing projections set out in the London Plan. As a result the assessment inherently takes into account a level of future growth and development across London.
- 21.3.18 For future year assessments for the King Edward Memorial Park Foreshore site, the TfL East London HAM (ELHAM) has been used to test the strategic highway network impacts associated with this site. Construction traffic associated with other Thames Tideway Tunnel project sites using routes in this area has been included in the ELHAM scenarios.

Sensitivity testing

- 21.3.19 The 'core' assessment presented in the *TA* is based on the *Transport Strategy*. It examines the month(s) in which construction vehicle activity at this site would be greatest and uses the average daily number of construction lorry movements that would occur in that month. This is considered to be reasonable because it addresses:
- the time at which construction vehicle movements would be greatest at this site and there would be longer periods when the number of vehicle movements would be lower
 - although there may be occasions in the peak month when the number of lorry movements in one day might exceed the average daily figure, these would be limited. The number of instances would be small in the context of the overall construction period at this site and would be offset by other times when the number of construction vehicle movements would be lower than the average daily figure for the peak month
 - if lorry movements are required outside the typical hours of 08:00 to 18:00, this would be agreed in advance with TfL and the Local Highway Authority.
- 21.3.20 The need for sensitivity testing has been discussed with TfL. Such a test could be used to address:
- variation in construction vehicle numbers around the average daily figure for the peak month

- b. a lower level of river transport for construction materials (leading to an increased number of lorry movements)
 - c. changes in programme which might lead to construction activity peaking at different times and/or a greater coincidence of peaks at adjacent sites which could lead to higher construction lorry flows on the surrounding highway network
- 21.3.21 As para 21.3.17 explains, if construction vehicle numbers were to exceed the average daily figure for the peak month, this would be an infrequent occurrence and should be seen in the context that the assessment is based on the peak month of construction activity at each site, rather than a lower 'typical' month.
- 21.3.22 It is expected that river transport will be used for certain construction materials and this forms part of the Transport Strategy. It is therefore not likely that all materials would be moved by road at all sites. However, there is the possibility that river transport might not be available at a particular site or sites for short periods of time and this might be the result of temporary navigational constraints, local issues temporarily preventing access to the river, or wider issues restricting river movements to a number of sites (such as the closure of the Thames Barrier).
- 21.3.23 In practice the potential for increased coincidence of construction peaks between sites is limited because of the sequential nature of the construction activities required. Whilst it is possible that individual site peaks might change slightly, it is very unlikely that all sites would experience peak activity in the same period.
- 21.3.24 Although these events, if they were to arise, would be limited and short-term, it has been agreed with TfL that sensitivity testing would be undertaken within the *TA* to identify the potential impacts associated with such occurrences. It has also been agreed that for consistency, the test would be based on the number of construction lorry movements that would be related to moving all construction materials by road. This has been assumed to act as a proxy for events of this nature and represents an upper bound on the level of construction traffic that could be expected.

Operation

- 21.3.25 The assessment methodology for the operational phase follows that described in the *Project-wide TA*. There are no site specific variations for undertaking the operational assessment of this site.
- 21.3.26 Given the local impact of the transport activity associated with the Thames Tideway Tunnel during the operational phase only the localised transport effects around the site are assessed. Other Thames Tideway Tunnel sites would not affect the area around the site and therefore they are not considered in this assessment.
- 21.3.27 With regard to other developments in the vicinity of the site (as detailed in Vol 21 Appendix N of the *Environmental Statement*), all developments identified would be complete and operational by

Year 1 of operation. As a result, these developments have been included within the operational base case which takes into consideration the effects on highway layout and operation.

Operational assessment area

- 21.3.28 The assessment area for the operational assessment remains the same as for the construction assessment as set out in paras 21.3.8 and 21.3.9.

Operational assessment year

- 21.3.29 The operational assessment year has been taken as Year 1 of operation. As the number of vehicle movements associated with the operational phase is low, there is no requirement to assess any other year beyond that date.

21.4 Baseline

- 21.4.1 This section sets out the baseline conditions on the local transport network in the vicinity of the site in 2012, with the exception of the traffic survey data which was collected in 2011.

Policy review

- 21.4.2 The site is located within the LB of Tower Hamlets; the relevant national, local and regional policy documents have been reviewed, this is presented in Appendix A.

Existing land use

- 21.4.3 The site would occupy part of the foreshore of the River Thames and would also include part of the existing King Edward Memorial Park and the riverside footway.
- 21.4.4 The surrounding area is predominantly residential in character with the nearest residents to the site situated 4m on the southern side of the site hoarding along the site haul road.

Existing access

- 21.4.5 There is an existing vehicular access in the south-west corner of the park via Glamis Road which is used to access a maintenance storage area. There is also a vehicle access point at the north end of Glamis Road.
- 21.4.6 The Thames Path routes through the Park along the riverside footway. The Park is closed at night and Thames Path users are diverted via The Highway (A1203) and Glamis Road.

Pedestrian network and facilities

- 21.4.7 The key pedestrian network to and from the site is directly related to local public transport services, particularly London Underground services and bus services. The key pedestrian routes related to the site are:

- a. The Thames Path
 - b. Glamis Road – providing connections on foot to bus stops on Glamis Road to the immediate west of the site
- 21.4.8 Glamis Road, Cable Street and Watney Street – providing connections on foot to Shadwell DLR station to the northwest of the site
- 21.4.9 Glamis Road, Wapping Wall and Wapping High Street – providing connections on foot to Wapping Rail Station to the southwest of the site
- 21.4.10 Glamis Road, the Highway (A1203) and Ratcliffe Lane - providing connections on foot to Limehouse National Rail and DLR station to the north-east of the site.
- 21.4.11 The existing pedestrian network and facilities in the vicinity of the site are described below and shown in Figure 21.4.1 in the King Edward Memorial Park Foreshore *Transport Assessment* figures.

Thames Path

- 21.4.12 The Thames Path (a Public Right of Way) provides a continuous east-west link for pedestrians along the north bank of the River Thames. The Thames Path runs through the Park along the riverside footpath. The Park is closed at night and Thames Path users are diverted via The Highway (A1203) and Glamis Road during this time. Plate 21.4.1 shows the Thames Path at King Edward Memorial Park riverside.

King Edward Memorial Park

- 21.4.13 There are a number of designated pedestrian paths within King Edward Memorial Park that link the entrance points and the riverside footpath.
- 21.4.14 Plate 21.4.2 shows the Thames Path within King Edward Memorial Park and Plate 21.4.2 shows a footpath within King Edward Memorial Park.

**Plate 21.4.1 Thames Path at King Edward Memorial Park
riverside**



Plate 21.4.2 King Edward Memorial Park



The Highway (A1203) and Glamis Road

- 21.4.15 Footways are located on both sides of The Highway (A1203) and Glamis Road varying in width from 1.9m to 2.4m on Glamis Road and between 3.7m and 4.4m on The Highway (A1203). Pedestrian crossing facilities are incorporated into the signalised junction of The Highway (A1203) with Glamis Road. The signal timings operate with a 'green man' pedestrian phase in each signal cycle.
- 21.4.16 There is also a staggered signalised pedestrian crossing with a pedestrian refuge approximately 200m east of The Highway (A1203) / Glamis Road signalised junction.
- 21.4.17 Plate 21.4.3 shows a view along Glamis Road towards its junction with The Highway and Plate 21.4.4 shows a view westbound along The Highway at its junction with Glamis Road.

Plate 21.4.3 Glamis Road towards its junction with The Highway



Plate 21.4.4 The Highway looking west at its junction with Glamis Road



Cycle network and facilities

- 21.4.18 The existing cycle network and facilities in the vicinity of the site are described below and shown in Figure 21.4.1 in the King Edward Memorial Park Foreshore *Transport Assessment* figures.
- 21.4.19 The main cycle route within the area is the National Cycle Network (NCN) Route 13 which is a national route that routes from Tower Bridge through east London, parallel to the River Thames, eastwards into Essex, Suffolk and Norfolk. The nearest part of NCN Route 13 is approximately 270m walking distance to the north of the site on Cable Street.
- 21.4.20 A designated London Cycle Network routes north and south along Glamis Road to Cable Street in the north and then continues east and west along Cable Street. The crossroads junction formed by Glamis Road and The Highway (A1203) has advanced cycle stop line facilities on the Glamis Road approaches.
- 21.4.21 London Cycle Routes 1 and 4 are also within close proximity of the site.

Barclays Cycle Superhighways

- 21.4.22 Barclays Cycle Superhighways (CS) are new cycle routes that route between central London and outer London providing cyclists with safer, faster and more direct journeys into the city. The cycle lanes have bold road markings and signage which increase awareness among other road users. They incorporate information about journey times and links to other cycle routes along these CS routes.

- 21.4.23 The closest CS to the site is CS3 which routes between Tower Gateway and Barking. CS3 runs along Cable Street which is approximately 270m walking distance to the north of the site.

Plate 21.4.5 CS3 on Cable Street at its junction with Brodlove Lane



Barclays Cycle Hire scheme

- 21.4.24 The closest Barclays Cycle Hire docking station is located within the western footway of Garnet Street approximately 620m walking distance or less than eight minutes walking time to the east of the site access and can accommodate 23 cycles.

Cycle parking

- 21.4.25 Two Sheffield cycle stands are located within the southern footway of Wapping Road at the Wapping Rail Station approximately 650m walking distance to the southwest of the site.

Public transport

Public Transport Accessibility Level

- 21.4.26 The Public Transport Accessibility Level (PTAL) of the site has been calculated using TfL's approved PTAL methodology and is included in Appendix B. This assumes a walking speed of 4.8km/h and considers rail stations within a 12 minute walk (960m) of the site and bus stops within an eight minute walk (640m).
- 21.4.27 Using this methodology the site has a PTAL rating of 3, rated as 'moderate' (with 1a being the lowest accessibility and 6b being the highest accessibility).

21.4.28 The following sections detail the public transport services in the vicinity of the site which are shown on Figure 21.4.2 in the King Edward Memorial Park Foreshore *Transport Assessment* figures.

Bus services

- 21.4.29 A total of seven daytime bus routes operate within 640 – 700m walking distance of the site. These bus routes operate from the following bus stops:
- a. Exmouth Estate bus stop on Commercial Road (A13), 680m north of the site, westbound only
 - b. Cable Street bus stop on Glamis Road, 180m north of the site, southbound only
 - c. King Edward Memorial Park bus stop on Glamis Road, 80m north of the site, northbound and southbound.
- 21.4.30 Table 21.4.1 provides a summary of the bus services and their frequencies during the weekday peaks.

Table 21.4.1 Existing daytime weekday peak hour local bus services and frequencies (number of buses per hour)

Bus number	Origin – destination	Nearest bus stop to King Edward Memorial Park Foreshore site	Approximate walking distance from King Edward Memorial Park Foreshore (m)	Weekday peak hour two-way frequencies	
				AM peak (08:00-09:00)	PM peak (17:00-18:00)
15	Blackwell Station to Conduit Street	Exmouth Estate	680	17	17
100	Elephant & Castle / Newington Causeway to St Georges Town Hall	Cable Street	180	15	18
115	East Ham / White Horse to Aldgate Station	Exmouth Estate	680	18	18
135	Crossharbour Asda to Provost Street/ Moorfields Eye Hospital	Exmouth Estate	680	14	13
339	Fish Island to Shadwell Station	Shadwell Station	700	8	4
381	County Hall to Peckham Bus Station	King Edward Memorial Park	80	13	12
D3	Isle of Dogs Asda to London Chest Hospital	Exmouth Estate	680	6	6

Source: Transport for London (TfL) (2011) Timetables. Available at www.tfl.gov.uk (site last accessed May 2012)

21.4.31 On average there are 91 daytime bus services in total per hour in the AM peak and 88 bus services in total per hour in the PM peak within a 640m of the site.

21.4.32 There are approximately 44 night-time bus services per hour Monday – Friday between 00:00 – 06:00 and a total of 51 night-time bus services per hour on Saturdays between 00:00 – 06:00 within 640m walking distance of the site.

Docklands Light Railway

21.4.33 As shown on Figure 21.4.2 in the King Edward Memorial Park Foreshore *Transport Assessment* figures, Shadwell DLR station is located approximately 700m walking distance or nine minutes walking time to the northwest of the site. Limehouse DLR station, which serves the same DLR route as Shadwell, is located approximately 1km walking distance or 12 minutes walking time to the northeast of the site.

21.4.34 DLR trains from Shadwell and Limehouse travel east to Woolwich Arsenal and Beckton and west to Tower Gateway and Bank. The frequency of the DLR trains from Shadwell and Limehouse is approximately every two to three minutes providing an average of 25 services per hour in each direction.

21.4.35 On average there are 50 DLR services in total during each of the AM and PM peak hours within a 960m walking distance of the site.

21.4.36 Table 21.4.2 provides a summary of the DLR and London Overground services and their frequencies during the weekday and weekend peaks.

London Overground

21.4.37 The closest London Overground station to the site is Wapping Rail Station, located approximately 650m walking distance or over 8 minutes walking time to the southwest of the site. Shadwell station also provides access to London Overground services. These services operate southwards to West Croydon and Crystal Palace and northwards to Highbury and Islington offering connections to National Rail, London Underground and other London Overground services.

21.4.38 In the AM peak hour there are approximately 26 services (12 southbound and 14 northbound) on the London Overground from Wapping and Shadwell. In the PM peak hour there are approximately 26 services (13 southbound and 13 northbound).

21.4.39 Table 21.4.2 provides a summary of the DLR and London Overground services and their frequencies during the weekday and weekend peaks.

**Table 21.4.2 Existing DLR and London Overground weekday peak hour services and frequencies
(number of services per hour)**

Line	Origin - destination	Approximate walking distance from King Edward Memorial Park Foreshore site (m)	Weekday peak hour two-way frequencies	
			AM peak (08:00-09:00)	PM peak (17:00-18:00)
DLR	Bank - Lewisham	700	30	26
DLR	Bank - Woolwich Arsenal	700	14	12
DLR	Tower Gateway - Becton	700	14	12
London Overground	West Croydon: Shadwell, Wapping, Rotherhithe, Canada Water, Surrey keys, New Cross, New Cross Gate, Brockley, Honor Oak Park, Forest Hill, Sydenham, Crystal Palace, Penge West, Anerley, West Norwood, West Croydon	650	8	8
London Overground	Crystal Palace: Shadwell, Wapping, Rotherhithe, Canada Water, Surrey keys, New Cross, New Cross Gate, Brockley, Honor Oak Park, Forest Hill, Sydenham,	650	8	8
London Overground	New Cross: Shadwell, Wapping, Rotherhithe, Canada Water, Surrey keys, New Cross	650	8	8
London Overground	Highbury & Islington: Shadwell, Whitechapel, Shoreditch High Street, Hoxton, Haggerston, Dalston Junction, Canonbury, Highbury & Islington	650	20	16
London Overground	Dalston Junction: Shadwell, Whitechapel, Shoreditch High Street, Hoxton, Haggerston, Dalston Junction	650	8	8

Source: Transport for London (TfL) (2011) Timetables. Available at www.tfl.gov.uk (site last accessed May 2012)

National Rail

- 21.4.40 The nearest National Rail station to the site is at Limehouse, approximately 1km walking distance or 12 minutes walking time to the north-east of the site. Limehouse station serves c2c services to Fenchurch Street, Shoeburyness, Tilbury, Grays and Laindon.
- 21.4.41 There are 15 westbound and five eastbound services calling at Limehouse in the AM peak hour and five westbound and 14 eastbound services in the PM peak hour.
- 21.4.42 Table 21.4.3 summarises the National Rail services and frequencies during the weekday peaks.

River services

- 21.4.43 There are no operational wharves, jetties or piers in the immediate vicinity of the site. The nearest river passenger services stop at the Hilton Pier which is approximately 1.5km downstream on the south bank of the River Thames. On the north bank, the nearest river passenger services stop is at the Canary Wharf and St Katharine's piers which are located approximately 2km downstream and 2.2km upstream of the site respectively.
- 21.4.44 Services at Canary Wharf pier operate between Woolwich Arsenal to the east and Embankment to the west. Services at St Katherine's pier operate between Greenwich to the east and Westminster to the west. Both services operate at 20 minute intervals during peak periods.

River navigation

- 21.4.45 An analysis has been made of the typical volume of river vessel traffic passing the site, based on published river passenger service timetables and estimates of freight traffic based on discussions with operators.
- 21.4.46 It is estimated that the peak hour for river vessel traffic passing the site is between 16:00 and 17:00 hours, Monday to Friday, during which it is estimated that approximately 33 vessels typically pass the site. This figure, however, is not constant as freight vessel transit patterns are influenced by the rising and falling tide. Therefore, such a peak will only occur every ten to 12 days when the tide is at its highest or lowest.
- 21.4.47 It should be noted that the Shadwell Basin Outdoor Activity Centre moors a number of sailing dinghies to a pontoon in the Thames within close proximity of the site. These are used by club members for sailing on the River Thames.
- 21.4.48 The frequency distribution of all the services that stop at the piers close to the site is shown in Table 21.4.4

Table 21.4.3 Existing National Rail weekday peak hour services and frequencies (number of services per hour)

National Rail station	Destination	Approximate walking distance from King Edward Memorial Park Foreshore site (m)	Weekday peak hour two-way frequency	
			AM peak (08:00-09:00)	PM peak (17:00-18:00)
Limehouse	London Fenchurch St	1000	20	19
Limehouse	Southend Central	1000	4	6
Limehouse	Grays	1000	4	4
Limehouse	Shoeburyness	1000	4	6
Limehouse	Pitsea	1000	4	5
Limehouse	Laindon	1000	4	7

Source: Rail planner information and timetables: www.nationalrail.co.uk (site last accessed March 2012)

Table 21.4.4 Aggregated frequency (passing craft per hour)

King Edward Memorial Park Foreshore site	Time of day																	
	0600 - 0700	0700 - 0800	0800 - 0900	0900 - 1000	1000 - 1100	1100 - 1200	1200 - 1300	1300 - 1400	1400 - 1500	1500 - 1600	1600 - 1700	1700 - 1800	1800 - 1900	1900 - 2000	2000 - 2100	2100 - 2200	2200 - 2300	2300 - 0000
1	5	6	6	8	12	14	19	17	22	33	13	11	6	6	3	2	1	

Taxis

- 21.4.49 Currently there are no taxi ranks within a 640m walking distance of the site.

Highway network and operation

- 21.4.50 The site location is shown in Figure 21.2.1 in the King Edward Memorial Park Foreshore *Transport Assessment* figures; commercial vehicles would access the site directly from Glamis Road after approaching through The Highway (A1203) / Glamis Road junction.
- 21.4.51 Glamis Road is subject to a 20 mph speed limit. There is a 7.5 tonne weight restriction on Glamis Road on the bridge over Shadwell Basin south of the site access. Construction vehicles will not route over this bridge. There are also traffic calming measures in the form of speed cushions in place on Glamis Road.
- 21.4.52 The Highway (A1203) / Glamis Road junction is a four arm signalised crossroads. The Highway (A1203) has two lanes on entry and exit to the junction, while Glamis Road has one entry and one exit lane on each of its arms.
- 21.4.53 Approximately 800m east of the site, The Highway (A1203) forms a three arm signalised junction with Butcher Row. East of this junction, the A1203 becomes the Limehouse Link.
- 21.4.54 The Highway (A1203) forms part of the TLRN and will be used by construction vehicles. It is subject to a 30mph speed limit and provides two lanes of traffic in each direction. During off-peak hours, parking is permitted in designated bays at the kerbside along The Highway (A1203) which effectively reduces it to single lane operation in each direction at these locations. The Highway (A1203) is suitable for HGVs and long vehicles.
- 21.4.55 The modelling results for the baseline situation of the Glamis Road / the Highway (A1203) junction are shown in Table 21.4.14. The results show that the junction currently operates above theoretical capacity in the weekday AM and PM peak hours.

Parking

- 21.4.56 Figure 21.4.3 in the King Edward Memorial Park Foreshore *Transport Assessment* figures shows the locations of the existing car and coach parking within the vicinity of the site.

Existing on-street car parking

- 21.4.57 There are seven on-street car parking bays on the western side of Glamis Road which are subject to Controlled Parking Zone (CPZ) restrictions only permit holders are permitted to park here from 08:30 to 17:30, Monday to Friday.
- 21.4.58 There are 31 shared use and four resident on-street car parking bays on Wapping Wall which are subject to a CPZ. At all these parking bays restrictions apply between 08:00 and 17:30, Monday to Friday, with a

maximum stay of four hours. The shared use bays allow pay and display parking.

- 21.4.59 There are approximately 19 on-street car parking bays on The Highway (A1203) in the vicinity of the site, which are subject to a CPZ. Approximately ten on-street car parking bays are located immediately north of the Park and parking is permitted for permit holders only from 10:00 to 16:00, Monday to Saturday, with a maximum stay of one hour and no return within two hours. Approximately nine parking bays are located to the northwest of the site and permit holders only are permitted to park here from 07:00 to 19:00, Monday to Saturday, with a maximum stay of one hour and no return within two hours.
- 21.4.60 There are also two car parking bays for shared use and two motorcycle parking bays on Monza Street, which is approximately 300m southwest of the site access. These bays are subject to a CPZ. For the two shared use car parking bays restrictions apply from 08:00 to 17:30, Monday to Friday, with a maximum stay of four hours. The two motorcycle bays are for solo motorcycles only with no restrictions in place.
- 21.4.61 There is no designated parking for blue badge holders within close proximity to the site.
- 21.4.62 Table 21.4.5 summarises the parking restrictions and the number of bays on the roads in the vicinity of the site. The availability and usage of the car parking capacity on a weekday and a Saturday on the roads in the vicinity of the site are summarised in this section in Table 21.4.10.

Table 21.4.5 Existing on-street car parking

Road name	Type of parking restrictions and number of bays	
	Resident	Shared-use
Glamis Road	12	3
Monza Street	0	2
Wapping Wall	4	31

- 21.4.63 The results in Table 21.4.5 show there are 16 resident permit holder and 36 shared-use parking bays located on the surrounding roads. Glamis Road has the highest number of resident bays with 12 bays in total. Wapping Wall has the highest number of shared-use with 31 bays in total.

Existing off-street/private car parking

- 21.4.64 The Tobacco Dock multi-storey car park is located approximately 1km to the west of the site at Wapping Lane, Poplar. It is open 24 hours a day from Monday to Sunday and has a capacity of 580 car parking spaces.

Coach parking

- 21.4.65 There is a coach parking bay for a single coach situated on the south arm of Glamis Road directly adjacent to the northbound bus stop which is

operational between 08.30 and 17.30 with a maximum stay of four hours permitted.

Car clubs

- 21.4.66 Car clubs provide members with easy access to cars for short-term use. Cars are available as and when needed and allow members to access a car without purchase, storage and operational costs associated with owning a private car.
- 21.4.67 The closest car club parking space to the site is operated by Zipcar and is approximately 300m walking distance to the east of the site on Heckford Street where space for one car is provided.
- 21.4.68 A further car club parking space is operated by Hertz On Demand and is approximately 550m walking distance to the southwest of the site on Wapping Wall.
- 21.4.69 Two car club bays are available on Wapping High Street some 600m to the southwest of the site, which are operated by City Car Club.

Servicing and deliveries

- 21.4.70 There are no designated on-street loading bays in the vicinity of the site.

Baseline survey data

Description of data

- 21.4.71 Automatic Traffic Count (ATC) data was obtained from TfL for Cable Street, Glamis Road and Commercial Road (A13).
- 21.4.72 Five year accident data on roads in the vicinity of the Hammersmith Pumping Station site was also obtained from TfL. This data is discussed in paras 21.4.128-125 to 21.4.136.
- 21.4.73 Baseline survey data were collected in May, July, and August / September 2011 to establish the existing transport movements in the area. Manual and automated traffic surveys were undertaken to establish specific traffic, pedestrian and cycle movements including turning volumes, queue lengths, saturation flows, degree of saturation and traffic signal timings where applicable. Figure 21.4.4 in the King Edward Memorial Park Foreshore *Transport Assessment* figures shows the survey locations in the vicinity of the King Edward Memorial Park site. Appendix A of the *Project-wide Transport Assessment* includes the *Baseline Data Report* which sets out the data collection in further detail.
- 21.4.74 The scope of the surveys in terms of location and time periods was considered to ensure that the data required for assessment was collected. Junction turning count data was collected at junctions that TfL had advised required assessment. In some cases, ATC data was collected on links to validate the junction turning count data and provide information for noise and air quality assessments.
- 21.4.75 Traffic surveys were carried out on a weekday and a weekend to represent a weekly profile of traffic at particular locations. Where two weekly profiles have been surveyed, the busiest survey was used.

21.4.76 The surveys undertaken and their locations are summarised in Table 21.4.6 and shown on Figure 21.4.4 in the King Edward Memorial Park Foreshore *Transport Assessment* figures.

Table 21.4.6 Survey locations

Survey type and location	Date
Junction turning movement survey (including pedestrian and cycle movements)	
Glamis Road / The Highway (A1203)	18th May 2011 and 21st May 2011
Brodlove Lane / The Highway (A1203)	
Butcher Row / The Highway (A1203) / Limehouse Link	26 th May 2011 and 21 st May 2011
Cable St (B126) / Butcher Row (B126)	12 th July 2011 and 9 th July 2011
Butcher Row / Commercial Road (A13) / White Horse Road	19 th May 2011 and 21 st May 2011
Flamborough Street / Yorkshire Road / Commercial Street (A13) / Branch Road (A101).	
Cable Street/ Schoolhouse Lane	12 th July 2011 and 9 th July 2011
The Highway (A1203)/ Schoolhouse Lane	
Automatic Traffic Count (ATC)	
Glamis Road	21 st May 2011 to 10 th June 2011
Cable Street	21 st May 2011 to 23 rd May 2011
Commercial Road (A13)	21 st May 2011 to 10 th June 2011
Pedestrian and cycle surveys	
A1203 The Highway – between Brodlove Lane and Glamis Road	18 th May 2011 and 21 st May 2011
River frontage – King Edward Memorial Park Foreshore	14 th July 2011 and 9 th July 2011
Path at SE corner of King Edward Memorial Park Foreshore	18 th May 2011 and 21 st May 2011
East side of Glamis Road at Southwest access to King Edward Memorial Park Foreshore	24 th August 2011 and 27 th August 2011
West side of Glamis Road at Southwest access to King Edward Memorial Park Foreshore	

Survey type and location	Date
Parking surveys	
Milk Yard	18 th May 2012 and 21 st May 2011
Monza Street	
Wapping Wall	
Glamis Road	
Redcastle Close	
Glamis Place	

21.4.77 Pedestrian and cyclist flow data from the surveys provided the baseline pedestrian traffic data sets which are set out in Table 21.4.8 and Table 21.4.9.

21.4.78 Vehicular traffic flow data from the junction turning movement surveys provided the baseline vehicular traffic data sets which were input into the junction assessment models described in para.21.4.116.

21.4.79 The following ATC and junction surveys are on construction traffic routes to and from the Hammersmith Pumping Station site:

- a. Glamis Road ATC
- b. Commercial Road (A13) ATC
- c. Glamis Road / The Highway (A1203) junction survey
- d. Brodlove Lane / The Highway (A1203) junction survey
- e. The Highway (A1203) / Schoolhouse Lane junction survey
- f. Butcher Row / The Highway (A1203) / Limehouse Link junction survey
- g. Cable St (B126) / Butcher Row (B126) junction survey
- h. Butcher Row / Commercial Road (A13) / White Horse Road junction survey
- i. Flamborough Street / Yorkshire Road / Commercial Street (A13) / Branch Road (A101) junction survey.

Results of the surveys

21.4.80 The surveys inform the analysis of the baseline situation in the area surrounding the King Edward Memorial Park Foreshore site. The findings are summarised in the following sections.

Pedestrians

21.4.81 Table 21.4.7 presents the pedestrian flows surrounding the site during the AM, PM and weekend peak hours. These flows indicate that there is a relatively balanced flow of pedestrians during the AM peak hour along the riverside footway by the river Thames, within the Park, with approximately 65 pedestrian movements in each direction. During the PM peak hour the flow is lower with approximately 52 southwest-bound pedestrians and 34 north-eastbound pedestrians on the same footway.

- 21.4.82 There is a balanced flow of pedestrians crossing The Highway (A1203) from Brodlove Lane during the AM peak hour of approximately 11 and 16 pedestrians in the northbound and southbound directions respectively. During the PM peak hour the flow is approximately 13 northbound movements and four southbound movements.
- 21.4.83 There are increased pedestrian flows along both the footpath of King Edward Memorial Park, adjacent to the river, and the footpath east of Butcher Row (through the green space) with average flows of 60 eastbound and north-eastbound movements during the AM peak hour and 30 westbound and southbound movements in the PM peak hour.
- 21.4.84 There are relatively the same pedestrian movements along the footpath of the eastern side of Glamis Road at the south-west access to King Edward Memorial Park.
- 21.4.85 There are slight further increases in pedestrian movements along the footpath of the south-eastern corner of King Edward Memorial Park with average flows of 90 in the AM peak hour and 65 in the PM peak hour.

Table 21.4.7 Existing pedestrian flows

Road/route	Direction	Weekday			Weekend (13:00-14:00)
		AM peak (08:00-09:00)	Inter-peak (12:00-13:00)	PM peak (17:00-18:00)	
Crossing on The Highway (west of Brodlove Lane)	Northbound	11	14	13	12
Crossing on The Highway (west of Brodlove Lane)	Southbound	16	1	4	13
Footpath at King Edward Memorial Park, adjacent to river	Northeastbound	69	174	34	113
Footpath at King Edward Memorial Park, adjacent to river	Southwestbound	63	160	52	63
Footpath east of Butcher Row (through green space)	Eastbound	52	10	16	18
Footpath east of Butcher Row (through green space)	Westbound	23	7	21	17
Footpath at southeast corner of King Edward Memorial Park					
	North path to riverside path west	0	6	3	0
	North path to riverside path east	4	4	2	0
	Riverside path west to north path	1	0	7	2
	Riverside path west to riverside path east	94	187	61	55
	Riverside path east to north path	2	1	1	2
	Riverside path east to riverside path west	68	200	73	51
East side of Glamis Road at southwest access to King Edward Memorial Park					
	Glamis Road north to King Edward Memorial Park access	0	1	6	3
	Glamis Road north to Glamis Road south	8	6	8	13

Transport Assessment

Road/route	Direction	Weekday			Weekend (13:00-14:00)
		AM peak (08:00-09:00)	Inter-peak (12:00-13:00)	PM peak (17:00-18:00)	
King Edward Memorial Park access to Glamis Road north		1	0	0	0
King Edward Memorial Park access to Glamis Road north		32	69	74	23
Glamis Road south to Glamis Road north		2	3	14	1
Glamis Road south to King Edward Memorial Park access		47	109	55	32
West side of Glamis Road at south-west access to King Edward Memorial Park					
Glamis Road north to King Edward Memorial Park access		0	0	0	0
Glamis Road north to Glamis Road south		4	14	12	2
King Edward Memorial Park access to Glamis Road north		0	0	0	1
King Edward Memorial Park access to Glamis Road north		14	57	10	5
Glamis Road south to Glamis Road north		6	4	6	3
Glamis Road south to King Edward Memorial Park access		10	42	11	5

Cyclists

- 21.4.86 Cycle flows within the area indicate the existing usage of the Thames Path and other cycle routes in the area surrounding the site. Table 21.4.8 indicates the flows of bicycles along the main routes surrounding the site.
- 21.4.87 Table 21.4.8 indicates that the Thames Path is relatively well used by cyclists but that flows on NCN routes are not substantial during either peak hour. This may reflect the presence of route CS3 located 300m walking distance to the north on Cable Street which provides an alternative east-west cycle route. However, the cycle flows indicate that there is a great increase of cyclists along the footpath east of Butcher Row (through green space) with flows of 330 eastbound and 239 in the westbound directions in the AM peak hours. This number decreases in the PM peak hour with 145 travelling eastbound and 206 westbound in the PM peak hour.

Table 21.4.8 Existing cycle traffic

Road/route	Direction	Weekday			Weekend (13:00-14:00)
		AM peak (08:00-09:00)	Inter-peak (12:00-13:00)	PM peak (17:00-18:00)	
The Highway with Brodlove Lane	Northbound	1	0	0	0
The Highway with Brodlove Lane	Southbound	1	0	0	0
Footpath adjacent to River Thames	Northeastbound	32	3	21	19
Footpath adjacent to River Thames	Southwestbound	32	7	25	14
Footpath east of Butcher Row (through green space)	Eastbound	330	15	145	52
Footpath east of Butcher Row (through green space)	Westbound	239	19	206	30
Path at SE corner of King Edward Memorial Park	Eastbound	54	3	19	6
Path at SE corner of King Edward Memorial Park	Westbound	39	6	22	15
East side of Glamis Road at SW access to King Edward Memorial Park Foreshore	Northbound	17	6	14	17
East side of Glamis Road at SW access to King Edward Memorial Park Foreshore	Southbound	11	4	6	7
West side of Glamis Road at SW access to King Edward Memorial Park Foreshore	Northbound	6	1	5	1
West side of Glamis Road at SW access to King Edward Memorial Park Foreshore	Southbound	13	6	14	2

Traffic flows

21.4.88 The ATC data has been analysed to identify the existing traffic flows along Glamis Road, Cable Street and Commercial Road (A13) for the weekdays, Saturdays and Sunday periods surveyed.

21.4.89 The weekday vehicle and HGV flows for Glamis Road for a 12-hour period (07:00-19:00) are shown in Plate 21.4.4. Weekday flows are presented as this is when the greatest impacts from the project are likely to be experienced.

Plate 21.4.6 Existing traffic flow along Glamis Road (weekday ATC survey)

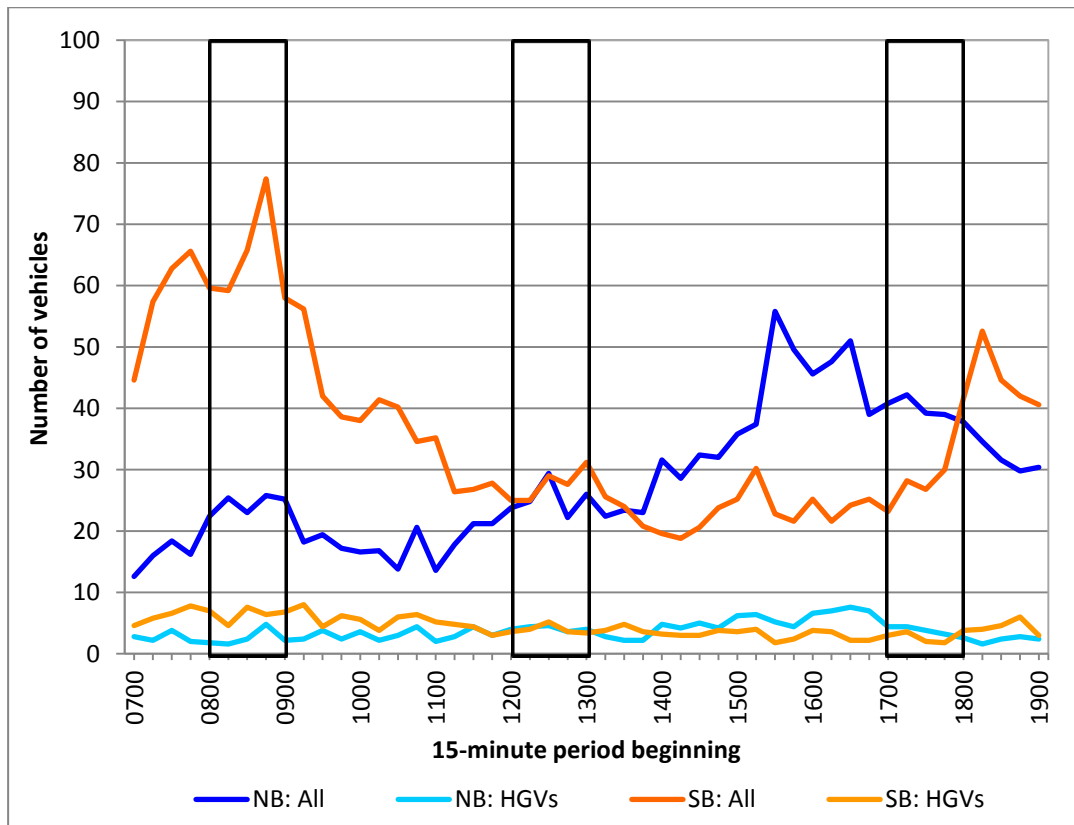

NB – Northbound, SB – Southbound. The black box represents the peak hour traffic flows used for the traffic assessment

21.4.90 The weekday ATC data for Glamis Road shows that between 08:00 – 09:00 there are approximately 359 two-way vehicle movements. The busiest 15 minute peak period in this period occurred after 08:45 with approximately 26 northbound vehicles and approximately 77 southbound vehicles.

21.4.91 For the period between 17:00 – 18:00 there are approximately 269 two-way vehicle movements. The busiest 15 minute peak period in this period occurred after 17:45 with approximately 42 northbound vehicles and approximately 28 southbound vehicles.

21.4.92 The weekday vehicle and HGV flows for Cable Street for a 12-hour period (07:00-19:00) are shown in Plate 21.4.5.

Plate 21.4.7 Existing traffic flow along Cable Street (weekday ATC survey)

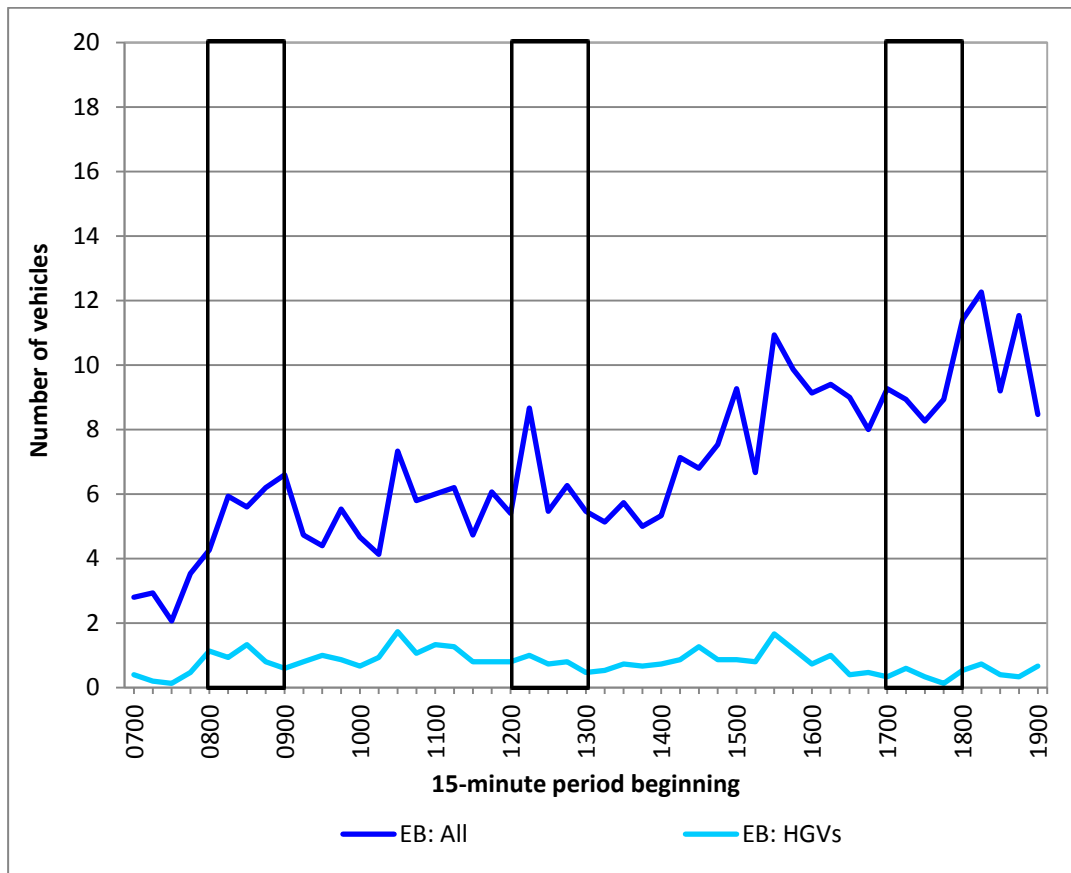

EB - Eastbound. The black box represents the peak hour traffic flows used for the traffic assessment

- 21.4.93 The weekday ATC data for Cable Street (one-way street) shows that between 08:00 – 09:00 there are approximately 22 one-way vehicle movements. The busiest 15 minute peak period in this period occurred after 08:45 with approximately six eastbound vehicles.
- 21.4.94 For the period between 17:00 – 18:00 there are approximately 35 one-way vehicle movements. The busiest 15 minute peak period in this period occurred after 17:00 with approximately nine eastbound vehicles.
- 21.4.95 The weekday vehicle and HGV flows for Commercial Road (A13) for a 12-hour period (07:00-19:00) are shown in Plate 21.4.6.
- 21.4.96 The weekday ATC data shows that between 08:00 – 09:00 there are approximately 2,155 two-way vehicle movements. The busiest 15 minute peak period in this period occurred after 08:30 with approximately 188 eastbound vehicles and approximately 362 westbound vehicles.
- 21.4.97 For the period between 17:00 – 18:00 there are approximately 2,160 two-way vehicle movements. The busiest 15 minute peak period in this period occurred after 17:15 with approximately 252 eastbound vehicles and approximately 281 westbound vehicles.

Plate 21.4.8 Existing traffic flow along Commercial Road (weekday ATC survey)

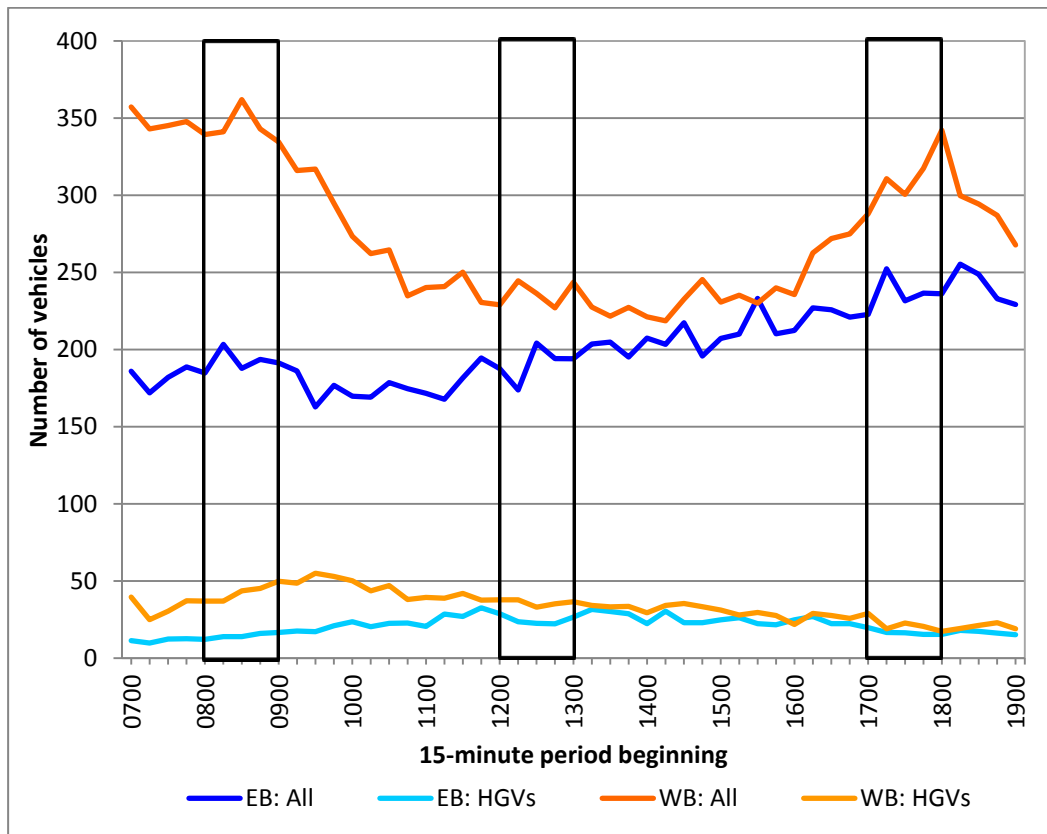

EB – Eastbound, WB – Westbound. The black box represents the peak hour traffic flows used for the traffic assessment

21.4.98 The Saturday vehicle and HGV flows for Glamis Road for a 12-hour period (07:00-19:00) are shown in Plate 21.4.7.

Plate 21.4.9 Existing traffic flow along Glamis Road (Saturday ATC survey)

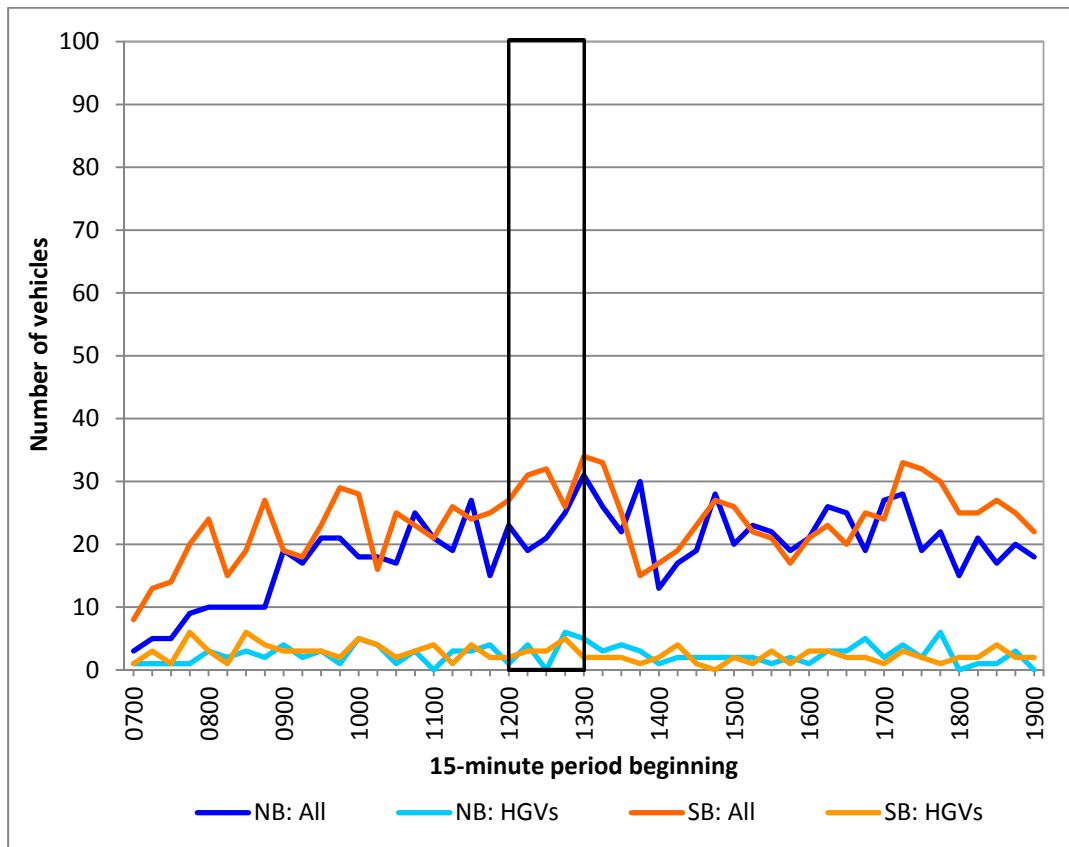

NB – Northbound, SB – Southbound. The black box represents the peak hour traffic flows used for the traffic assessment

- 21.4.99 Analysis of the data showed that the Saturday peak travel period occurred between 12:15 – 13:15 with 228 two-way vehicle movements recorded. This is less than the AM and PM weekday two-way traffic flows and the period falls within the normal weekend construction works vehicle movements period of between 08:00 – 13:00. As a result no additional assessment on a Saturday has been undertaken.
- 21.4.100 The Saturday vehicle and HGV flows for Cable Street for a 12-hour period (07:00-19:00) are shown in Plate 21.4.8.

Plate 21.4.10 Existing traffic flow along Cable Street (Saturday ATC survey)

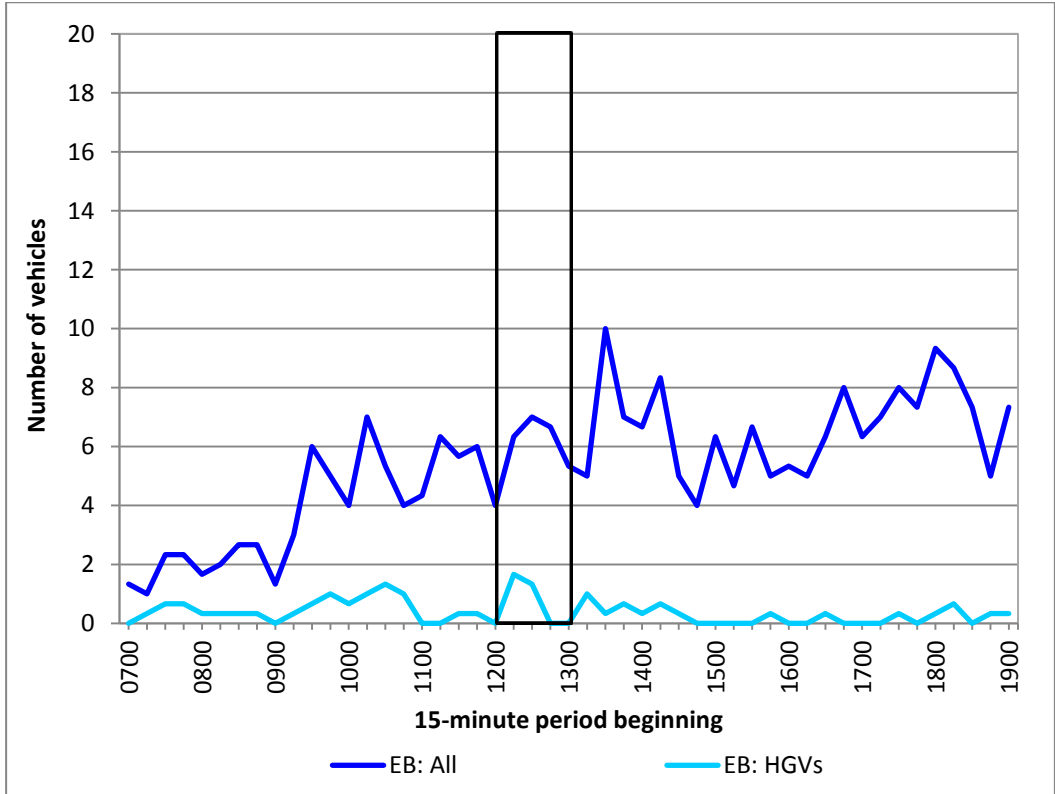

EB - Eastbound. The black box represents the peak hour traffic flows used for the traffic assessment

- 21.4.101 Analysis of the data showed that the Saturday peak travel period occurred between 17:30 – 18:30 with 33 one-way vehicle movements recorded. This is less than the PM weekday two-way traffic flows and the period falls outside of the normal weekend construction works vehicle movements period of between 08:00 – 13:00. As a result no additional assessment on a Saturday has been undertaken.
- 21.4.102 The Saturday vehicle and HGV flows for Commercial Road (A13) for a 12-hour period (07:00-19:00) are shown in Plate 21.4.9.
- 21.4.103 Analysis of the data showed that the Saturday peak travel period occurred between 16:30 – 17:30 with 1,979 two-way vehicle movements recorded. This is less than the AM and PM weekday two-way traffic flows and the period falls outside of the normal weekend construction works vehicle movements period of between 08:00 – 13:00. As a result no additional assessment on a Saturday has been undertaken.

Plate 21.4.11 Existing traffic flow along Commercial Road (Saturday ATC survey)

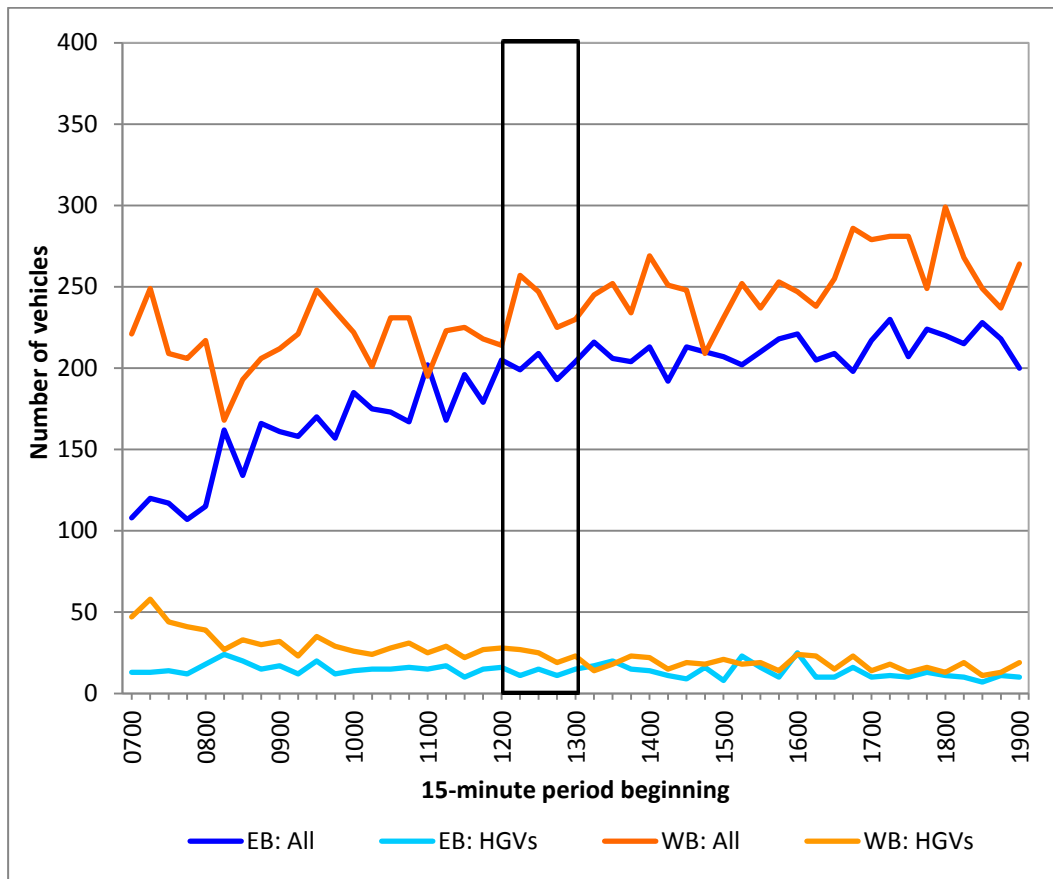

EB – Eastbound, WB – Westbound. The black box represents the peak hour traffic flows used for the traffic assessment

21.4.104 The Sunday vehicle and HGV flows for Glamis Road for a 12-hour period (07:00-19:00) are shown in Plate 21.4.10.

Plate 21.4.12 Existing traffic flow along Glamis Road (Sunday ATC survey)

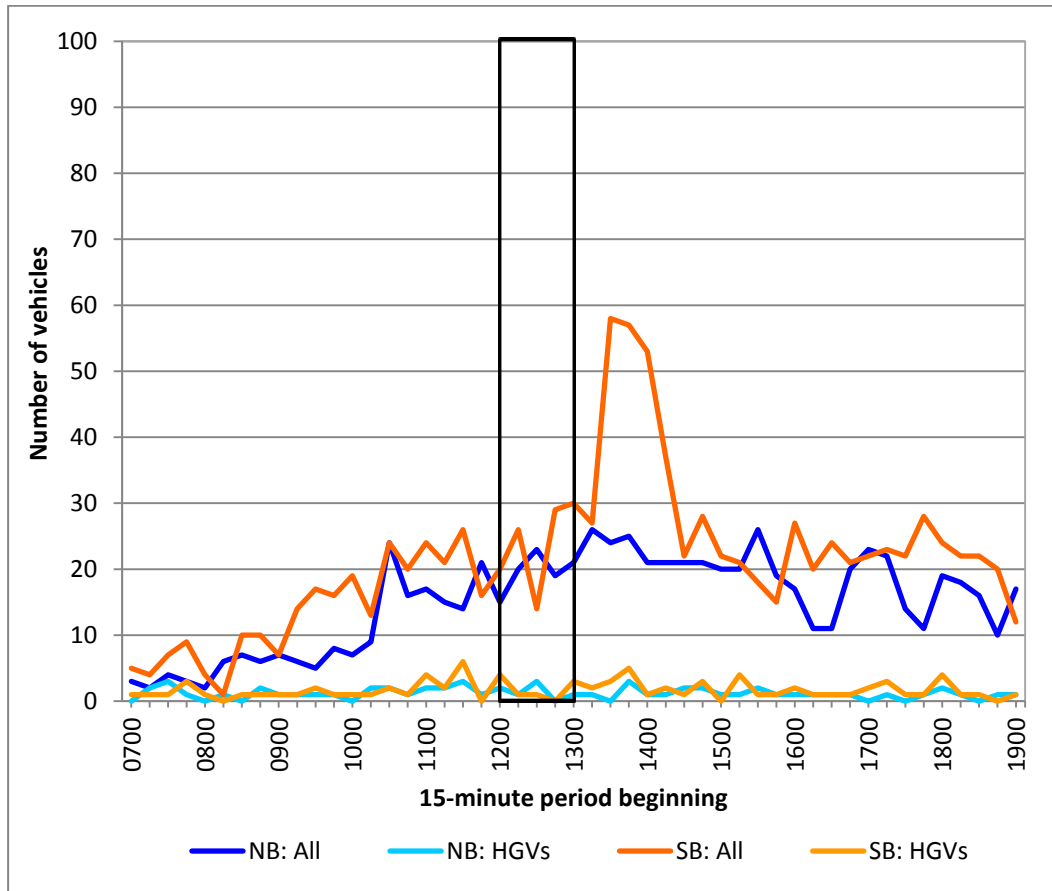

NB – Northbound, SB – Southbound. The black box represents the peak hour traffic flows used for the traffic assessment

21.4.105 Analysis of the data showed that the Sunday peak travel period occurred between 13:15 – 14:15 with 296 two-way vehicle movements recorded. This is less than the AM weekday two-way traffic flows and the period falls outside of the normal weekend construction works vehicle movements period of between 08:00 – 13:00. As a result no additional assessment on a Sunday has been undertaken.

21.4.106 The Sunday vehicle and HGV flows for Cable Street for a 12-hour period (07:00-19:00) are shown in Plate 21.4.11.

Plate 21.4.13 Existing traffic flow along Cable Street (Sunday ATC survey)

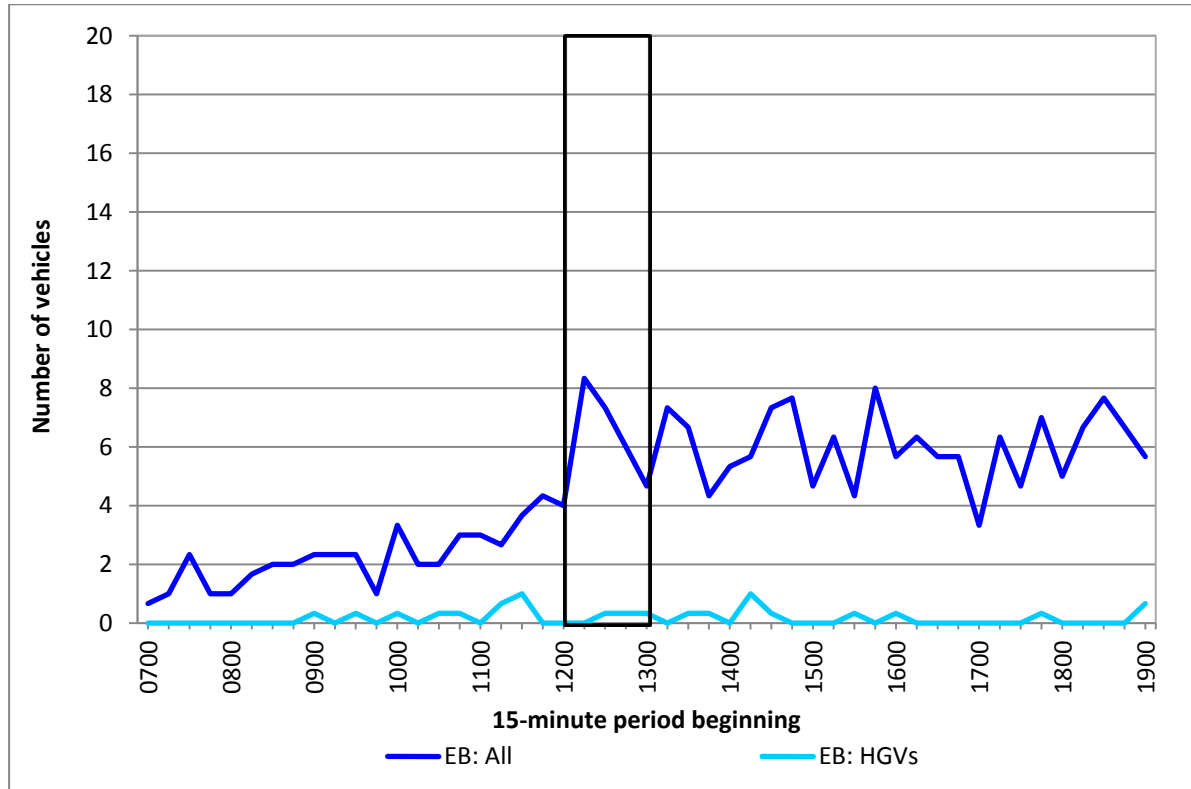

EB - Eastbound. The black box represents the peak hour traffic flows used for the traffic assessment

21.4.107 Analysis of the data showed that the Sunday peak travel period occurred between 19:30 – 20:30 with 30 one-way vehicle movements recorded. This is very slightly higher than the PM weekday two-way traffic flows and the period falls outside of the normal weekend construction works vehicle movements period of between 08:00 – 13:00. As a result no additional assessment on a Sunday has been undertaken.

21.4.108 The Sunday vehicle and HGV flows for a 12-hour period (07:00-19:00) on Commercial Road (A13) are shown in Plate 21.4.12.

Plate 21.4.14 Existing traffic flow along Commercial Road (Sunday ATC survey)

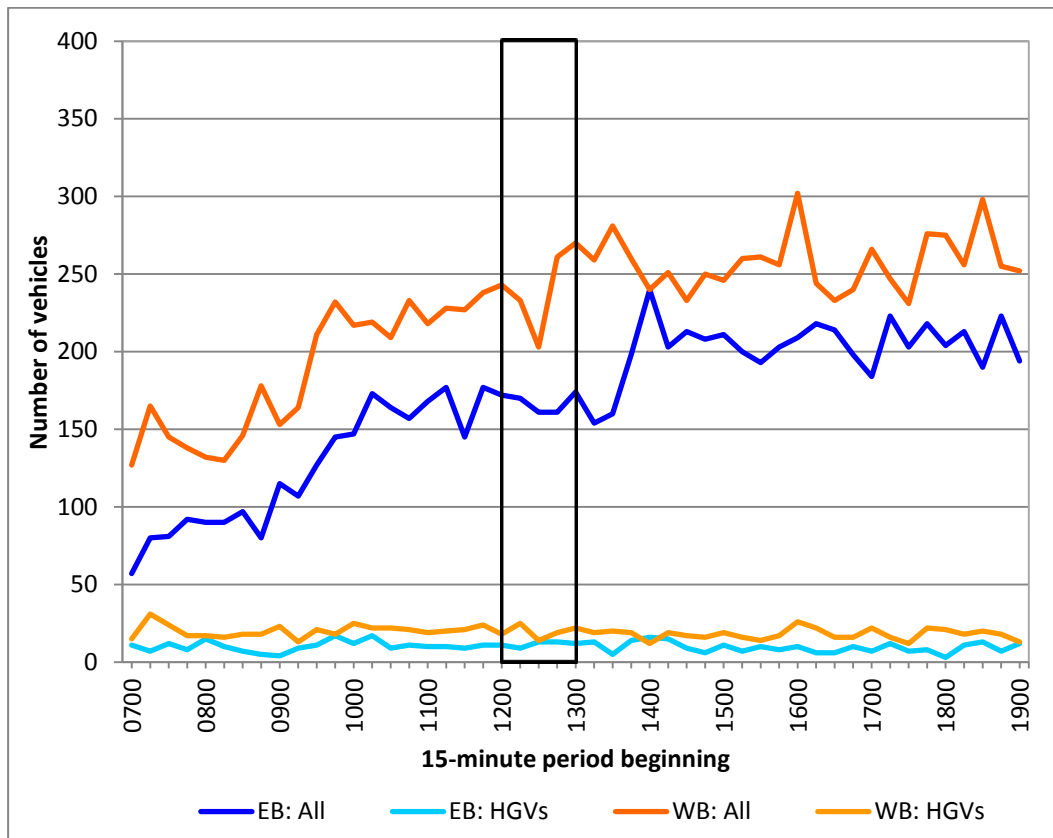

EB – Eastbound, WB – Westbound. The black box represents the peak hour traffic flows used for the traffic assessment

- 21.4.109 Analysis of the data showed that the Sunday peak travel period occurred between 17:30 - 18:30 with 1,930 two-way vehicle movements recorded. This is less than the AM and PM weekday two-way traffic flows and the period falls outside of the normal weekend construction works vehicle movements period of between 08:00 – 13:00. As a result no additional assessment on a Sunday has been undertaken.
- 21.4.110 A comparison of the junction survey data against the ATC survey data for the Glamis Road/ The Highway (A1203) indicates that:
- a. there is a total traffic flow of 3,781 and 4,066 vehicles in the AM and PM peak hours respectively using the junction of The Highway (A1203) / Glamis Road. The dominant traffic flow is 3,186 vehicles traveling through the junction along the A1203 in the AM peak hour and 3,449 vehicles in the PM peak hour.
 - b. The TfL data for the junction of The Highway (A1203) / Glamis road indicates that there is a total traffic flow of 3,186 and 4,138 vehicles using this junction in the AM and PM peak hours respectively.
- 21.4.111 Comparison of the junction survey against the TfL junction survey data used in the TRANSYT modelling shows that the TfL junction survey data is slightly higher for the PM peak hour, though the number of vehicles in the two data sets is similar. For the AM peak hour, the junction survey data is lower than the traffic surveys. The close correlation between the PM

figures would suggest the AM difference in vehicle numbers is an uncharacteristic variation in junction use.

Parking

- 21.4.112 Surveys were undertaken to establish the availability of parking stock in the vicinity of the site to understand existing occupancy and capacity.
- 21.4.113 Plate 21.4.13 shows a histogram of the car parking availability and usage in the area surrounding King Edward Memorial Park Foreshore site during the AM, inter-peak and PM peaks on a weekday and during the weekend peak periods. These surveys were undertaken before the relocation of the coach parking bay on Glamis Road.

Plate 21.4.15 On-street parking capacity

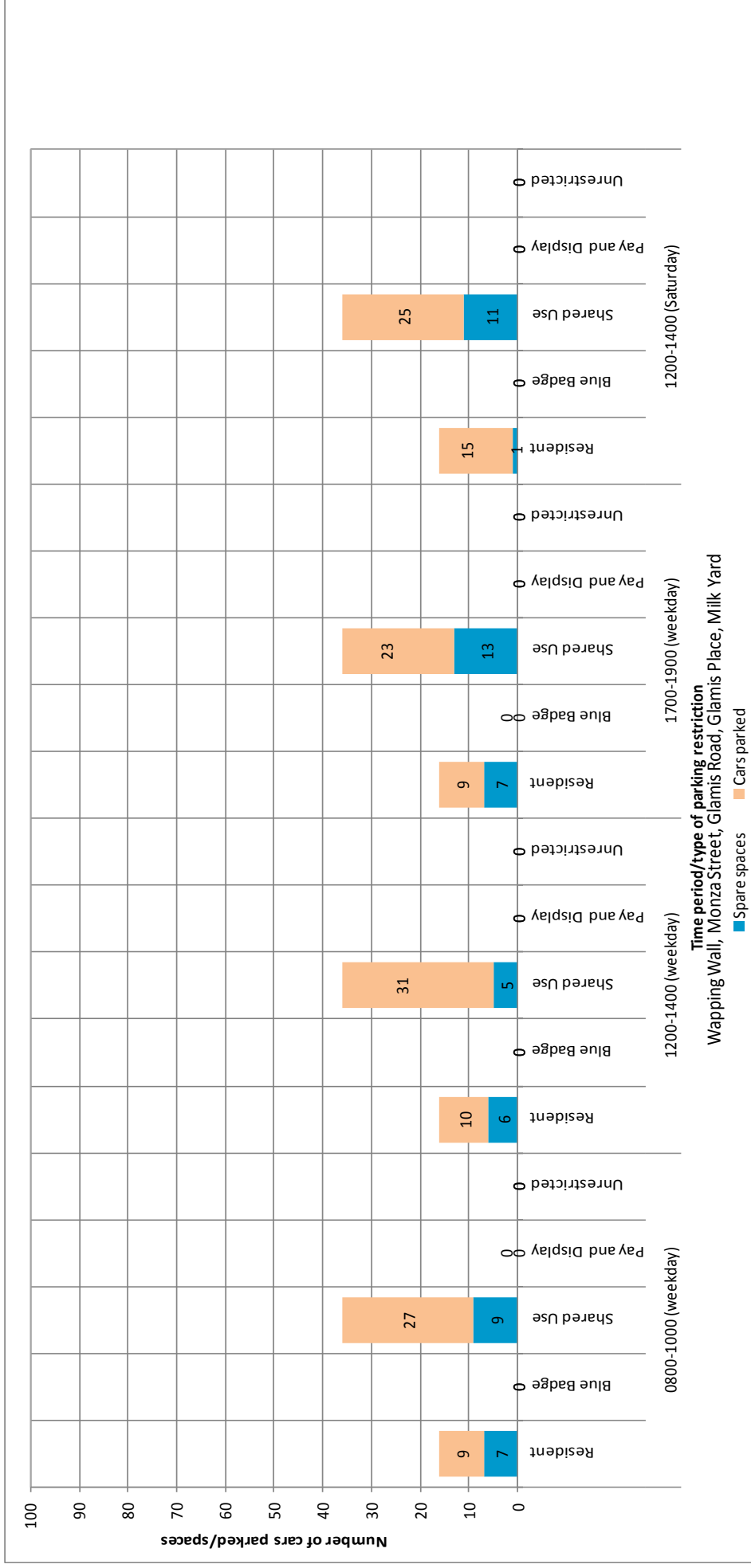

21.4.114 Table 21.4.10 shows the parking availability and usage in the vicinity of the site on a weekday and Saturday.

Table 21.4.9 Parking bay availability and usage

Location	Number and Type of Bays		No. of spaces available			
			Weekday			Saturday
			08:00-10:00	12:00-14:00	17:00-19:00	12:00-14:00
Glamis Road	No. of coach bays	1	NS	NS	NS	NS
	No. of parking bays	15	5	3	5	0
Monza Street	No. of parking bays	2	2	2	2	1
Wapping Wall	No. of parking bays	35	9	6	13	12

Note – NS means no survey was undertaken

21.4.115 The results of the surveys indicate that the on-street parking along the streets described in paras 21.4.53 to 21.4.60 is moderately well used but that there is spare capacity available on both weekdays and at weekends. It was estimated that the total capacity of the on-street parking in the vicinity of the site is approximately 52 cars.

21.4.116 The parking survey suggested that about 30% of all available spaces were used throughout the day. The utilisation is slightly higher in the Saturday and weekday inter-peak when compared to the AM and PM weekday peaks.

21.4.117 The results of the surveys show that the greatest demand for parking within the vicinity of the site occurs both during the weekday between 17:00 and 19:00 and at the weekend between 12:00 and 14:00. Overall, the results indicate that there are a number of available spaces during the time periods surveyed.

Local highway modelling

21.4.118 For the assessment of the local highway network, a scope was discussed with TfL and the LB of Tower Hamlets to model the Glamis Road / The Highway (A1203) junction in LinSig. The baseline models determine for the current traffic and transport conditions within the vicinity of the site.

21.4.119 Traffic models for this junction have been developed for this assessment and where possible suitable models from TfL have been used. The models have been constructed using on-site measurements of classified vehicle volumes and queue lengths.

21.4.120 The signal timings used in the assessment have been obtained from the TfL Signal Timing Sheet for this junction.

- 21.4.121 The TfL modelling guidelines and Modelling Audit Process (MAP) have been used as the basis for preparing and checking models and their outputs. All required input data has been used in order to calibrate the model. Where TfL models have been used, saturation flows have been retained where no change is proposed to junctions; where changes are proposed, saturation flows have been calculated and compared with site observations to determine suitable values. Validation of the models has been based on observed data including signal timings, vehicle volumes and queue lengths to provide the key criteria for comparison with modelled queue lengths.
- 21.4.122 The models are considered suitable for this planning stage and are intended to demonstrate the nature of the effects of the additional vehicles generated by the Thames Tideway Tunnel project in this location. It is acknowledged that these models may require further refinement as the project moves from planning to detailed design stage; however, as a period of time will elapse before construction commences at this site, it will be necessary in any case to review and revalidate the models against traffic conditions at that time, as is normal practice.
- 21.4.123 Figures 21.4.5 and 21.4.6 in the King Edward Memorial Park Foreshore *Transport Assessment* figures show the traffic flows which were used for the baseline AM and PM peak hour assessments which take into account the observed flows.
- 21.4.124 Table 21.4.11 shows the modelling outputs for the Glamis Road / The Highway (A1203) junction.

Table 21.4.10 Baseline LinSig model outputs

Approach	Movement	Weekday											
		AM peak hour (08:00-09:00)					PM peak hour (17:00-18:00)						
		Flow (PCU)	DoS	MMQ (PCU)	Delay (seconds per PCU)	Flow (PCU)	DoS	MMQ (PCU)	Delay (seconds per PCU)	Flow (PCU)	DoS	MMQ (PCU)	Delay (seconds per PCU)
Glamis Road (N)	Ahead	92	45%	3	65	92	40%	3	61				
	Left Ahead	987	93%	35	41	864	89%	28	36				
	Right	987	93%	35	41	864	91%	29	41				
Glamis Road (S)	Left Ahead	93	46%	3	68	202	88%	10	107				
	Left Ahead	756	61%	16	16	941	82%	27	28				
The Highway (W)	Right	756	57%	15	15	940	77%	25	25				
		Practical Reserve Capacity (PRC)			Total Delay (PCU Hours)	Practical Reserve Capacity (PRC)			Total Delay (PCU Hours)			Total Delay (PCU Hours)	
Overall junction performance			-3.6%		33		-0.9%		40				

Notes: DoS represents Degree of Saturation; the ratio of flow to capacity. MMQ represents Mean Maximum Queue for the busiest-case 15 minute modelled period (in vehicle lengths). Delay represents the mean delay per PCU. PCU represents Passenger Car Unit. PRC represents Practical Reserve Capacity; measure of how much additional traffic could pass through a junction whilst maintaining a maximum DoS of 90% on all lanes. PCU value for a car is one PCU. Vans and three-axle vehicles are 1.5 PCUs, vehicles with four or more axles are 2.3 PCUs. Buses and coaches are two PCUs. Motorcycles are 0.4 PCUs and pedal cycles are 0.2 PCUs.

- 21.4.125 The results in Table 21.4.11 demonstrate that the Glamis Road / The Highway (A1203) junction is currently operating above the theoretical capacity in the weekday AM and PM models. The validated model indicates that the AM peak hour is the busiest period with 987 PCUs on the eastern arm of The Highway (A1203). In this period the majority of all arms operate below capacity, with the exception of The Highway eastern arm which operates above capacity with maximum queues of approximately 35 vehicle lengths.
- 21.4.126 The delay to vehicles is most significant during the PM peak hour on the Glamis Road approach on its southern arm, which currently indicates an average of 107 seconds of delay per PCU. The LinSig junction model output shows that total junction delay is 33 PCU hours in the AM peak period assessed and 41 PCU hours in the PM peak period assessed. These equate to 32 seconds per PCU in the AM peak period assessed and 37 seconds per PCU in the PM peak period assessed.
- 21.4.127 Model outputs are included in Appendix C which indicates the lane structure used for the assessment of the junction.

Accident analysis

- 21.4.128 A total of one fatal accident, 15 serious accidents and 49 slight accidents occurred in the assessment area over the five year period of accident data analysed.
- 21.4.129 The one fatal accident occurred at the junction of The Highway (A1203) with Glamis Road. The accident involved a motorcyclist travelling on the wrong side of an island and hitting a turning Light Goods Vehicle (LGV).
- 21.4.130 The majority of the serious accidents occurred on The Highway (A1203) at or near its junctions with Glamis Road, Dellow Street and King David Lane.
- 21.4.131 Four serious accidents occurred at the junction of The Highway (A1203) / Glamis Road and three serious accidents occurred at the junction of The Highway / Dellow Street.
- 21.4.132 Of the total accidents, one involved a Light Goods Vehicles (LGV) and none involved Medium or Heavy Goods Vehicles (MGV/HGV).
- 21.4.133 Of the five year accident data analysed, none of the accident reports described road geometry as being a contributing factor to the cause of the accident.
- 21.4.134 Table 21.4.6 and Figure 21.4.7 in the King Edward Memorial Park Foreshore site *Transport Assessment* figures indicate the accidents that have occurred within the vicinity of the site between 2006 and 2011.

Table 21.4.11 Accident severity from 2006 to 2011

Location	Slight	Serious	Fatal	Total
A1203 The Highway	6	1	0	7
The Highway / Glamis Road Junction	14	4	1	19
The Highway / King David Lane Junction	13	2	0	15
The Highway / Dellow Street Junction	3	3	0	6
The Highway / Brodlove Lane Junction	4	1	0	5
The Highway / Schoolhouse Lane Junction	3	1	0	4
The Highway / Garnet Street Junction	6	1	0	7
The Highway / Garnet Road Junction	0	1	0	1
Brodlove Lane / Glamis Place Junction	0	1	0	1

- 21.4.135 Figure 21.4.8 in the King Edward Memorial Park foreshore *Transport Assessment* figures shows the pedestrian and cyclist accidents by severity.
- 21.4.136 The records show that there were 11 accidents involving pedestrians and / or cyclists. Only one incident occurred on the roads to be taken by construction vehicles within the study area. Inspection of the data showed that three of these 11 incidents occurred at junctions with signalised control facilities, with the remaining accidents occurring at locations without signal control.
- 21.4.137 In the context of the construction HGV movements associated with the King Edward Memorial Park Foreshore site, the accident risk to these modes of travel would be managed by providing pedestrian and cyclist awareness training for commercial drivers associated with the construction works as set out in the *CoCP*. For sections of road affected by roadworks, the risk to all road users would be managed by the contractor(s) in accordance with the provisions made under the Traffic Signs Manual Chapter 8 - Traffic Safety Measures and Signs for Road Works (DfT, 2009)³.
- 21.4.138 Appendix D provides a full analysis of accidents within the local area surrounding the site.

21.5 Construction assessment

- 21.5.1 The assessment, including both qualitative and quantitative analysis has been undertaken drawing on discussions with TfL and the Local Highway Authorities, knowledge of the transport networks and their operational characteristics in the vicinity of each site and the knowledge of the construction programme, duration and levels of construction activity.
- 21.5.2 The construction assessment compares a construction base case, which represents transport conditions in the assessment year without the Thames Tideway Tunnel project, with a construction development case, which represents conditions with the Thames Tideway Tunnel under construction. The construction base case does not include any traffic related to the Thames Tideway Tunnel, whether from the King Edward Memorial Park Foreshore site or from other sites.

Construction base case

- 21.5.3 As described in Section 21.3, the construction assessment year for transport effects in relation to the King Edward Memorial Park Foreshore site is Site Year 1 of construction for construction road traffic and Site Year 3 for construction river traffic.

Pedestrians and cyclists

- 21.5.4 There are no proposals to change the cycle or pedestrian network by Site Year 1 of construction and the construction base case for these networks is therefore the same as indicated in the baseline description in Section 21.4.

Public transport

- 21.5.5 In terms of the public transport network; at the time of undertaking the assessment there were no plans to change DLR or National Rail services in the area. It is envisaged that DLR, London Overground and National Rail patronage will increase by Site Year 1 of construction. However, the London Overground line extension between Highbury & Islington and West Croydon has now been completed but is not included in this assessment.
- 21.5.6 All other planned line upgrades included in the TfL London Underground Upgrade Plan, such as capacity improvements on Jubilee, Victoria, Northern, Hammersmith and City, Circle, Metropolitan and District lines, are also planned to be in place by the construction base case.
- 21.5.7 Due to traffic growth in the construction base case compared to the baseline situation, the LinSig junction model output for the Glamis Road / The Highway (A1203) junction shows that total junction delay has increased from 33 PCU hours to 87 PCU hours in the AM peak period assessed and from 40 PCU hours to 73 PCU hours in the PM peak period assessed. These equate to an increase in delay of 45 seconds per PCU in the AM peak period assessed and 24 seconds per PCU in the PM peak period assessed. The maximum increase in delay for buses occurs in the AM peak with an increase in delay between the baseline and construction base case of 82 seconds.

- 21.5.8 It is anticipated that patronage on public transport services may change between the baseline situation and Site Year 1 of construction. Future patronage changes on bus, rail and river networks will be driven by a range of complex factors and there are inherent uncertainties in setting a patronage level for a future year. Further capacity improvements are anticipated on the Bakerloo, Piccadilly and Central lines however the best way of delivering these improvements, including the timescales, are currently being investigated by TfL. At this stage, Thames Tideway Tunnel are unable to estimate how much of these upgrades will have been completed by the construction base case or how much will be remaining.
- 21.5.9 In order to ensure that the busiest case scenario is addressed in the assessment, the capacity for National Rail, Overground and DLR services in the base case has been assumed to remain the same as capacity in the baseline situation. This ensures a robust assessment.

River navigation

- 21.5.10 There are no known current proposals to alter river navigation passenger services or river navigation patterns from the current baseline conditions and therefore the construction base case remains similar to the baseline position.

Highway network operation

- 21.5.11 Baseline traffic flows (from the junction surveys) have been used and forecasting carried out to understand the capacity on the highway network in the vicinity of the site in Site Year 1 of construction without the Thames Tideway Tunnel project. The scope of this analysis has been discussed with the LB of Tower Hamlets and TfL.
- 21.5.12 Strategic highway network modelling has been undertaken at a project-wide level using the TfL HAMs, which include forecasts of employment and population growth in line with the London Plan. Growth factors have been derived at individual Borough level by comparing the 2008/9 base and 2021 forecast years in the HAMs, as described in the *Project-wide TA*.
- 21.5.13 It should be noted that these represent growth over the period to 2021, which is beyond Site Year 1 of construction at the site and therefore ensures that the construction base case for the highway network is robust.

Committed developments

- 21.5.14 The development of John Bell House on King David Lane and the former land bounded by Schoolhouse Lane, Cable Street and Glasshouse Fields development would result in 330 new residential units located 150m and 100m respectively from the site.
- 21.5.15 These developments have been taken into account in the local highway modelling and the assessment of the site.

Local highway modelling

- 21.5.16 The growth factors for the LB of Tower Hamlets based on the ELHAM model have been discussed with TfL and the LB of Tower Hamlets and applied to the baseline traffic flows. The growth factors are:
- Weekday AM Peak growth factor – 11.1%

b. Weekday PM Peak growth factor – 11.2%

21.5.17 Paras 21.3.7 to 21.3.11 explains the definition of the assessment area for local highway network modelling. At this site, the assessment examines only the nearest junction of the construction vehicle route with the TLRN.

21.5.18 Table 21.5.1 shows the construction base case model outputs.

Table 21.5.1 Construction base case LinSig model outputs

Approach	Movement	Weekday							
		AM peak hour (08:00-09:00)				PM peak hour (17:00-18:00)			
		Flow (PCU)	DoS	MMQ (PCU)	Delay (seconds per PCU)	Flow (PCU)	DoS	MMQ (PCU)	Delay (seconds per PCU)
Glamis Road (N)	Left Ahead Right	103	50%	4	67	102	47%	4	64
	Left Ahead	1097	104%	67	122	961	97%	40	60
The Highway (E)	Right Ahead	1097	104%	67	123	960	100%	46	83
	Ahead Right Left	103	51%	4	70	224	104%	18	225
Glamis Road (S)	Left Ahead	840	68%	19	18	1046	90%	35	36
	Ahead Right	840	63%	18	17	1045	84%	30	28
		Practical Reserve Capacity (PRC)		Total Delay (PCU Hours)		Practical Reserve Capacity (PRC)		Total Delay (PCU Hours)	
Overall junction performance		-15.1%		87		-15.6%		73	

Notes: DoS represents Degree of Saturation; the ratio of flow to capacity. MMQ represents Mean Maximum Queue for the busiest-case 15 minute modelled period (in vehicle lengths). Delay represents the mean delay per PCU. PCU represents Passenger Car Units. PRC represents Practical Reserve Capacity; measure of how much additional traffic could pass through a junction whilst maintaining a maximum DoS of 90% on all lanes. PCU value for a car is one PCU. Vans and three-axle vehicles are 1.5 PCUs, vehicles with four or more axles are 2.3 PCUs. Buses and coaches are two PCUs. Motorcycles are 0.4 PCUs and pedal cycles are 0.2 PCUs.

- 21.5.19 The resulting construction base case LinSig model for the site indicates that there would be an increase in queue lengths and changes to average delays at the junction of Glamis Road and The Highway (A1203) in the construction base case, compared to baseline conditions. The construction development case includes the optimisation of traffic signal timings in order to minimise journey time increases within the local area.
- 21.5.20 Overall the results indicate that the local network will continue to operate over capacity in the AM and PM peaks, when taking into account the construction base case traffic flows and signal optimisation. The LinSig junction model output shows that total junction delay has increased from 33 PCU hours to 87 PCU hours in the AM peak period assessed and from 40 PCU hours to 73 PCU hours in the PM peak period assessed. These equate to an increase in delay of 45 seconds per PCU in the AM peak period assessed and 24 seconds per PCU in the PM peak period assessed.

Construction development case

- 21.5.21 This section summarises the findings of the assessment undertaken for the peak year of construction at the site (Site Year 1 of construction).

Pedestrian routes

- 21.5.22 As a result of the construction phase at the site, as detailed in Section 21.2, changes would be made to the pedestrian network. The highway layout during construction plans in the King Edward Memorial Park Foreshore *Transport Assessment* figures show the effect on the pedestrian footways during construction.
- 21.5.23 To assess a busiest case scenario, it has been anticipated that all worker trips would finish their journeys by foot. As a result the 40 worker trips generated by the site have been added to the construction base case pedestrian flows during the AM and PM peak hours
- 21.5.24 The footways which would most likely to be affected by the worker trips would be Glamis Road, the Thames Path and King Edward Memorial Park. A forecast distribution of worker pedestrian trips can be determined by considering the mode split shown in Table 21.2.3 and the location of the nearest rail and DLR stations and bus stops. Based on this, it is assumed that approximately 75% would be travelling along Glamis Road or the Thames Path to the west of the site, and approximately 25% would be travelling along Thames Path and King Edward Memorial Park to the east and north of the site.
- 21.5.25 This would equate to a maximum of 30 construction workers in the AM and PM peak hours along Glamis Road or the Thames Path to the west of the site.
- 21.5.26 Within King Edward Memorial Park and the Thames Path to the north and east respectively of the site, there would be a around of ten workers in the AM and PM peak hours.
- 21.5.27 Given this small increase in pedestrian numbers against baseline usage an extension to the length of the pedestrian phase at the junction of The Highway (A1203) and Glamis Road is not required. In addition, as the

assessment assumes that all construction workers would travel in the peak hours, the increase in pedestrian numbers against baseline usage during the peak hours due to construction workers walking is considered to be a robust estimate because, due to the site working start and finish times, many workers will be travelling outside of peak network hours.

- 21.5.28 The existing Thames Path runs adjacent to the riverside footway of King Edward Memorial Park and would require diversion as a result of the proposed construction works. This would be necessary throughout the construction works and therefore the diversion would be away from the foreshore west around the northern hoarding of the site, and through the western part of the Park to Glamis Road. Alternatively pedestrians would be able to cross the access road at a designated gated crossing point supervised by a traffic marshal to use the existing access road to get to Glamis Road.
- 21.5.29 The increase in construction traffic flow on Glamis Road and within and around King Edward Memorial Park would be low. As the pedestrian flows on The Highway are also expected to be low this would result in a low increase in safety risk for pedestrians on Glamis Road. The additional traffic on The Highway due to construction vehicles would represent a small increase in the context of existing traffic flows and therefore the additional accident risk is very low.
- 21.5.30 Taking into consideration the pedestrian diversions and increase in worker trips the greatest effect would be on the pedestrian routes through King Edward Memorial Park and on Glamis Road to which pedestrians would be diverted from the riverside footway of the foreshore during construction activity.
- 21.5.31 It is anticipated that the pedestrian diversions around the site would result in a journey time increase of approximately two minutes 20 seconds, due to the extension of the journey by 180m, based on a walking speed of 1.3m/sec. This would affect those using the Thames Path and riverside footway within King Edward Memorial Park. The impact on other pedestrian movements in the area would be lower.
- 21.5.32 It would also be necessary for pedestrians using the eastern footway of Glamis Road to cross the site access. Appropriate protection and management measures would be provided at this location and the site is expected to generate approximately seven HGV movements an hour at the site access. Given pedestrian flows of approximately 525 people per hour this could introduce a slightly raised risk of pedestrian accidents in the local area.
- 21.5.33 With regards to pedestrian amenity and accidents and safety the diversion of the Thames Path would not result in pedestrians having to make any additional road crossings although it would be necessary to cross the site access within the Park for those who want to access Glamis Road via the existing access road rather than via the diversion to the north-western park access. Pedestrian flows would be approximately 130 people per hour. Pedestrian routes close to the site would require protection to segregate pedestrians and construction vehicle movements.

21.5.34 During all construction work and on any section of road subject to temporary diversions or restrictions imposed by road works associated with the King Edward Memorial Park Foreshore site, the risk to all road-users would be managed by the contractor(s) in accordance with the provisions made under the Traffic Signs Manual Chapter 8 - Traffic Safety Measures and Signs for Road Works (DfT, 2009)⁴. This will include compliance with the Equality Act 2010 (HM Government, 2009)⁵ to ensure safe passage for mobility and vision impaired pedestrians.

Cycle routes

- 21.5.35 Cyclists using the Thames Path would experience an additional delay to journey time as a result of the diversion of the Thames Path during construction works at the site. The effect on journey times would be an increase of a maximum of some 40 seconds over that in the construction base case based on a cycling speed of 16km/h. This represents a negligible impact
- 21.5.36 Cyclists using the highway network surrounding the site may experience minimal changes to their journey time. The effect on journey times is identified in the LinSig modelling which is outlined in the highway assessment section in Table 21.5.2 which would be a total increase of 7 seconds in the AM peak (The Highway (A1203) right ahead westbound approach) and 7 seconds in the PM peak across the same junction.
- 21.5.37 Cyclists using the Thames Path would be diverted to Glamis Road and would therefore have to pass the site access if they wish to route south, thus introducing the potential for interaction with construction traffic. Appropriate management and signage measures would be put in place but there would be a slightly raised risk of cycle accidents occurring in the local area.
- 21.5.38 The stop line and advanced cycle stop line on the southern Glamis Road arm of the Glamis Road / The Highway (A1203) signalised junction would need to be relocated south to enable large construction traffic to enter Glamis Road from The Highway without conflict with cyclists or vehicles at the stop line. The swept path movements plans in the King Edward Memorial Park Foreshore Site *Transport Assessment* figures show that construction vehicles cannot manoeuvre the left turn movement heading westbound from The Highway on to Glamis Road without some mitigation occurring to this signalised junction. The full width of Glamis Road would be maintained.
- 21.5.39 Construction vehicles serving the site will comprise a range of sizes and types, including light vans, rigid bodied vehicles and longer articulated vehicles. At this site the majority of the vehicles are expected to be medium or heavy rigid bodied goods vehicles.
- 21.5.40 With regard to accidents and safety; while cyclists would not be required to make any additional road crossings as a result of the construction works there would be an increase in construction traffic flows. This would lead to a minor increase in the risk of accidents to cyclists although there would be less than ten HGV movements per hour at the site and appropriate

signage would be provided to warn cyclists of the presence of large vehicles.

- 21.5.41 Measures set out in the *CoCP* described in paras 21.2.41 and 21.2.42 include increasing driver awareness of restrictions on the road network and marshalling of traffic at the site access. During all construction work and on any section of road subject to temporary diversions or restrictions imposed by road works associated with the King Edward Memorial Park Foreshore site, the risk to all road-users would be managed by the contractor(s) in accordance with the provisions made under the Traffic Signs Manual Chapter 8 - Traffic Safety Measures and Signs for Road Works (DfT, 2009)⁶. This would include compliance with TfL guidance (Cyclists at Roadworks – Guidance)^{iv} (DfT, 1999)⁷ to ensure safe passage for cyclists.

Bus routes and patronage

- 21.5.42 Bus services run immediately past the site on Glamis Road. However, the additional construction vehicles serving the site would not directly affect bus infrastructure along Glamis Road and within the wider area. The potential changes to bus journey times are detailed under the highway operation and network assessment (paras.21.5.61 to 21.5.63) and Table 21.5.2.
- 21.5.43 The maximum delay for Route D3 is from right/ahead/left turning traffic from Glamis Road southbound. In reality, as there is one lane approaching this junction, all traffic is required to queue to access the junction whether heading in a northern, western or southern direction.

Table 21.5.2 Estimated maximum delay for bus services

Bus Route Number	Maximum Delay per Vehicle
100	3 seconds - The Highway (A1203) left into Glamis Road, northbound PM peak
D3	13 seconds - The Highway (A1203) left into Glamis Road, southbound PM peak (none in AM Peak)

- 21.5.44 In the context of overall bus journey times for these routes the delay to bus services is not considered to be significant.
- 21.5.45 It is expected that approximately three additional two-way worker trips would be made by bus during the AM and PM peak hours. Based on a service of 91 and 88 buses within a 640m – 700m walking distance during the AM and PM peak hours respectively, this is equivalent to less than one additional passenger per bus service. On this basis the additional worker

^{iv} Traffic Advisory Leaflet 15/99 (December 1999) Cyclists at Roadworks – Guidance was produced by TfL and provides recommended lane widths at roadworks.

trips made by bus in peak hours would be capable of being accommodated on the base case bus services and would typically be well within the normal daily variation in bus patronage on these routes.

DLR and patronage

- 21.5.46 It is expected that there would be approximately 14 worker journeys made using DLR services in the AM and PM peak hours.
- 21.5.47 DLR provides 50 services per hour at Shadwell station. The additional worker journeys therefore represent less than one per train service on these networks, which is a negligible increase and could be accommodated on base case rail services.

London Overground and National Rail patronage

- 21.5.48 It is expected that there would be approximately 17 worker journeys made using London Overground or National Rail services in the AM and PM peak hours.
- 21.5.49 London Overground provides 20 services per hour in the peak hours at Limehouse station and there would be a further 26 National Rail services per hour at Wapping Rail station in the peak hours. The additional worker journeys therefore represent less than one per train service on these networks, which is a negligible increase and could be accommodated on base case rail services.

River services and patronage

- 21.5.50 There are no river passenger services in the immediate vicinity of the site and therefore it is not expected that the transport of construction materials by the river would directly affect such services.
- 21.5.51 During construction, no river passenger services would be altered as a result of the works at the site. It is anticipated that less than 1% of construction workers and labourers would use the river services to access the construction site, which would result in no construction worker travelling by river.

River navigation

- 21.5.52 During construction it is anticipated that 90% of cofferdam import and export and 90% of shaft excavation material would be transported by barge. The peak number of barge movements would occur in Site Year 3 of construction and would be an average of four barge movements a day.
- 21.5.53 Due to the low number of barges arriving at the site, it is anticipated that the changes to river navigation in the vicinity of the site would be minimal.
- 21.5.54 It is noted that a separate navigational risk assessment has been undertaken for the temporary construction works and barges to be used at the site.

Parking

- 21.5.55 As noted in Section 21.2 it is proposed that the site would be accessed at one location on Glamis Road. To accommodate the movement of construction vehicles into and out of the site access, it would be necessary to suspend approximately 15m of on-street car parking from the western

side of Glamis Road opposite the site access. The car parking would not be re-provided in the immediate vicinity of the site as there is no physical capacity to do so on the surrounding roads.

- 21.5.56 The current level of use of these bays shows typical usage of approximately 75% of capacity (See Plate 21.4.4 in Section 4).
- 21.5.57 Table 21.2.3 in Section 2 indicates that based on mode shares from the 2001 Census zero workers would be drive to the site over the course of the working day.
- 21.5.58 The removal of 15m of on-street car parking from Glamis Road would not create any significant issues for users parking in the local area as there would be sufficient spare capacity elsewhere in the vicinity of the site to accommodate displaced parking demand.
- 21.5.59 Measures would also be taken for this site to discourage workers from travelling by car, instead promoting the use of public transport, walking or cycling. These measures are included in the *Travel Plan* and *CoCP*.
- 21.5.60 The highway layout during construction phases plans in the King Edward Memorial Park Foreshore *Transport Assessment* figures summarises the proposed suspension and removal of on-street parking bays associated with the construction works at the site.

Highway assessment

Highway layout

- 21.5.61 The highway layout during construction phases plans in the King Edward Memorial Park Foreshore *Transport Assessment* figures show the highway layout during Phases 1, 2 and 3 of the construction works at the site.
- 21.5.62 The site is on the southern side of King Edward Memorial Park and would be accessed from Glamis Road. The swept path movements plans in the King Edward Memorial Park Foreshore *Transport Assessment* figures show the swept path movements and show that the construction vehicles would be able to safely enter and leave the site.
- 21.5.63 There are proposals to relocate the stop line and advanced cycle stop line on the southern Glamis Road arm of the Glamis Road / The Highway (A1203) signalised junction. The swept path movements plans in the King Edward Memorial Park Foreshore *Transport Assessment* figures show that construction vehicles cannot manoeuvre the left turn movement heading westbound from The Highway on to Glamis Road without some mitigation occurring to this signalised junction.

Highway network

- 21.5.64 Construction lorry movements would be limited to the day shift only (08:00 to 18:00). In exceptional circumstances and if it is necessary for vehicle movements to take place outside these hours, arrangements would be agreed in advance with LB Tower Hamlets. There would be a gated access for the right-turn in, left-turn out arrangement for construction traffic using Glamis Road.

- 21.5.65 Table 21.2.4 in Section 2 shows the vehicle movement assumptions for the local peak traffic periods based on the peak months of construction activity at this site.
- 21.5.66 Table 21.2.4 shows an average peak flow of 82 vehicle movements a day is expected during the months of greatest activity during Site Year 1 of construction at the King Edward Memorial Park Foreshore site. There are a further two months where vehicle movements exceed 70 a day. At other times in the construction period, vehicle flows would be lower than this average peak figure.
- 21.5.67 The busiest peak in the AM and PM period for each type of movement (construction, other and worker) has been combined in the development case and assessed against the peak hour operation of the highway network. In reality, not all peaks for these movements will occur concurrently and the peak for worker trips will be outside of the highway network peak hour, therefore the assessment is considered to be robust.
- 21.5.68 The *Project-wide TA* explains the method used to assign construction traffic to the HAMs, from which the likely changes in turning movements at local junctions have been identified and added to the construction base case flows.
- 21.5.69 The assignment of construction lorry trips has been undertaken using OmniTrans^v software, which enables a fixed assignment to be created for these trips in order to ensure that they are assigned only to the proposed construction routes. The OmniTrans outputs also identify lorry traffic which would be associated with the King Edward Memorial Park Foreshore site, or with other Thames Tideway Tunnel project sites, that would use routes in the vicinity of the King Edward Memorial Park Foreshore site. Figure 21.5.1 in the King Edward Memorial Park Foreshore *Transport Assessment* figures shows the OmniTrans plot for the local road network around the King Edward Memorial Park Foreshore site.
- 21.5.70 It is anticipated that there would be no additional HGV movements associated with other Thames Tideway Tunnel sites on Glamis Road or The Highway (A1203) during the peak hours during Site Year 1 of construction at the King Edward Memorial Park Foreshore site as indicated on Figure 21.5.1 in the King Edward Memorial Park Foreshore *Transport Assessment* figures.
- 21.5.71 Changes to the highway network during construction and the additional construction traffic generated by the project may lead to local changes in traffic flow and capacity. Local modelling has been undertaken to assess the effect on the highway operation resulting from these changes.
- 21.5.72 The construction development case includes the optimisation of traffic signal timings in order to minimise journey time increases within the local

^v OmniTrans is a software package used for multi-modal transport network modelling and in this case has been used to produce assignments of construction traffic across the proposed network of routes to be used for the project

area. The local LinSig model has been used to apply the construction traffic demands and local geometrical changes to the construction base case to determine the changes in the highway network operation due to the project (ie, comparison of base and development cases).

- 21.5.73 The junction assessed in the modelling assessment was the signalised junction between The Highway and Glamis Road.
- 21.5.74 A summary of the construction assessment results for the junction for the weekday AM and PM peak hours is presented in Table 21.5.4.

Table 21.5.3 Construction development case LinSig model outputs (AM peak hour)

Approach	Arm	Flow (PCU)	Weekday										
			AM peak hour (08:00-09:00)										
			DoS			MMQ (PCU)			Delay (seconds per PCU)				
Base case	Dev't case	Change	Base case	Dev't case	Change	Base case	Dev't case	Change	Base case	Dev't case	Change		
Glamis Road (N)	Left Ahead	103	50%	50%	-	4	4	-	67	67	-	67	-
	Right		104%	104%	-	67	69	+2	122	129	+7	129	+7
The Highway (E)	Left Ahead	1102	104%	104%	-	67	69	+2	123	130	+7	130	+7
	Right Ahead		104%	104%	-	67	69	+2	123	130	+7	130	+7
Glamis Road (S)	Ahead Right	113	51%	56%	+5%	4	4	-	70	72	+2	72	+2
	Left		68%	68%	-	19	19	-	18	18	-	18	-
The Highway (W)	Left Ahead	840	63%	63%	-	18	18	-	17	17	-	17	-
	Ahead Right		63%	63%	-	18	18	-	17	17	-	17	-
			Practical Reserve Capacity (PRC)						Total Delay (PCU Hours)				
Overall junction performance			-15.1%	-15.7%	-0.6%				87	92	+3		

Notes: DoS represents Degree of Saturation; the ratio of flow to capacity. MMQ represents Mean Maximum Queue for the busiest-case 15 minute modelled period (in vehicle lengths). Delay represents the mean delay per PCU. PCU represents Passenger Car Unit. PRC represents Practical Reserve Capacity; measure of how much additional traffic could pass through a junction whilst maintaining a maximum DoS of 90% on all lanes. PCU value for a car is one PCU. Vans and three-axle vehicles are 1.5 PCUs, vehicles with four or more axles are 2.3 PCUs. Buses and coaches are two PCUs. Motorcycles are 0.4 PCUs and pedal cycles are 0.2 PCUs. Thames Tideway Tunnel construction vehicles would be a mixture of three- and four-axle vehicles and have therefore been given a PCU value of two.

Table 21.5.4 Construction development case LinSig model outputs (PM peak hour)

Approach	Arm	Flow (PCU)	Weekday											
			AM peak hour (17:00-18:00)					MMQ (PCUs)					Delay (seconds per PCU)	
			Base case	Dev't case	Change	Base case	Dev't case	Change	Base case	Dev't case	Change	Base case	Dev't case	Change
Glamis Road (N)	Left Ahead	102	47%	44%	-3%	4	4	-	64	62	-2			
	Right Ahead		97%	99%	+2%	40	45	+5	60	73	+13			
The Highway (E)	Left Ahead	965	100%	101%	+1%	46	50	+4	83	90	+7			
	Right Ahead		104%	102%	-2%	18	17	-1	225	201	-24			
Glamis Road (S)	Ahead Right	235	90%	92%	+2%	35	36	+1	36	39	+3			
	Ahead Left		84%	85%	+1%	30	31	+1	28	30	+2			
The Highway (W)	Left Ahead	1046	Practical Reserve Capacity (PRC)			Total Delay (PCU Hours)								
	Ahead Right		-15.6%	-13.8%	+1.8%	73	79	+6						

Notes: DoS represents Degree of Saturation; the ratio of flow to capacity. MMQ represents Mean Maximum Queue for the busiest-case 15 minute modelled period (in vehicle lengths). Delay represents the mean delay per PCU. PCU represents Passenger Car Unit. PRC represents Practical Reserve Capacity; measure of how much additional traffic could pass through a junction whilst maintaining a maximum DoS of 90% on all lanes. PCU value for a car is one PCU. Vans and three-axle vehicles are 1.5 PCUs, vehicles with four or more axles are 2.3 PCUs. Buses and coaches are two PCUs. Motorcycles are 0.4 PCUs and pedal cycles are 0.2 PCUs. Thames Tideway Tunnel construction vehicles would be a mixture of three- and four-axle vehicles and have therefore been given a PCU value of two.

- 21.5.75 The construction base case model indicates that the local highway will be operating over capacity in the AM peak and PM peaks without the Thames Tideway Tunnel proposals.
- 21.5.76 With inclusion of the construction traffic generated the construction development case indicates that the local highway will remain over capacity in the AM peak and PM peaks.
- 21.5.77 There is slight increase in demand resulting from the construction traffic. This affected the AM peak performance by increasing the degree of saturation by 5% on the Glamis Road northbound approach, no additional car lengths and additional delay of 2s per vehicle. It has also increased the queue by 2 vehicle lengths for The Highway (A1203) right ahead westbound approach, and additional delay of 7 seconds. The majority of vehicles undertaking these movements would be associated with the construction traffic.
- 21.5.78 This affected the PM peak performance by increasing the degree of saturation by 1% on The Highway (A1203) right ahead westbound approach, an additional queue of 4 car lengths and additional delay of 7s per vehicle. It has also increased the queue by 5 vehicle lengths for The Highway (A1203) left ahead westbound approach, and additional delay of 13 seconds. The majority of vehicles undertaking these movements would be associated with the construction traffic.
- 21.5.79 The LinSig junction model output shows that total junction delay is 92 PCU hours in the AM peak period assessed and 79 PCU hours in the PM peak period assessed. These equate to 80 seconds per PCU in the AM peak period assessed and 65 seconds per PCU in the PM peak period assessed.

Construction mitigation

- 21.5.80 The project has been designed to limit the issues arising on transport networks as far as possible and many measures have been embedded directly in the design of the project. These are summarised in Table 21.5.5.

Table 21.5.5 King Edward Memorial Park Foreshore site design measures

Phase	Issues	Design measures
Construction	Creating access point	<ul style="list-style-type: none"> Creation of a gated access for the left-turn in / right-turn out movement for construction traffic at existing site access point
	Thames Path	<ul style="list-style-type: none"> Diversion of route during construction works; manned throughout the day
	Street parking	<ul style="list-style-type: none"> Temporary suspension of 15m of car parking space on Glamis Road

Phase	Issues	Design measures
	Movement of construction traffic flows on the local highway network	<ul style="list-style-type: none"> • Maintaining a minimum 4.3m width for cyclists • Relocation of the stop line and advanced cycle stop line on the southern Glamis Road arm of the Glamis Road / The Highway (A1203) signalised junction.
Operation	Permanent access point	<ul style="list-style-type: none"> • Provision of permanent kerbing and gates at site access to accommodate maintenance vehicles - architect to advice on finishes / material

21.5.81 These embedded measures, discussed in Section 21.2 have been taken into account in the assessment. The outcomes indicate that with these measures in place the changes to be expected in the transport networks are not significant and therefore no additional measures are required for the construction phase.

21.5.82 As the assessment indicates that there would be no significant changes to the transport networks during construction, no other mitigation is required during the construction phase.

Sensitivity testing

Highway operation

21.5.83 A sensitivity test has been undertaken to examine the implications of variation in the number of construction vehicles in the peak month of activity at this site, including the possibility that river transport were not available for short periods of time which could temporarily increase vehicle numbers. In this sensitivity test, the number of construction vehicles would be a maximum of ten per hour in the AM and PM peak hours.

21.5.84 Changes to the highway network during construction and the additional construction traffic generated by the project may lead to local changes in traffic flow and capacity. Local modelling has been undertaken to assess the effect on the highway operation resulting from these changes.

21.5.85 The local LinSig models were used to apply the construction traffic demands and local highway layout changes to the sensitivity testing case to determine the changes in the highway network operation due to the project (ie comparison of base and sensitivity testing cases)

21.5.86 The sensitivity testing model includes the optimisation of traffic signal timings in order to maximise capacity and minimise overall delay at The Highway (A1203) / Glamis Road junction.

21.5.87 A summary of the sensitivity testing results for the LinSig model for The Highway (A1203) / Glamis Road junction in the weekday AM and PM peak hours using the sensitivity test figures is presented in Table 21.5.6 and Table 21.5.7.

Table 21.5.6 Sensitivity testing LinSig model outputs (AM peak hour)

Approach	Arm	Flow (PCU)	Weekday											
			AM peak hour (08:00-09:00)											
			DoS			MMQ (PCU)			Delay (seconds per PCU)					
Base case	Devt case	Sen. case	Base case	Devt case	Sen. case	Base case	Devt case	Sen. case	Base case	Devt case	Sen. case			
Glamis Road (N)	Left Ahead	103	50%	50%	50%	4	4	4	4	4	4	67	67	67
	Right		104%	104%	105%	67	69	72	122	129	139			
The Highway (E)	Left Ahead	1109	104%	104%	105%	67	69	72	123	130	138			
	Right Ahead		104%	104%	105%	67	69	72	123	130	138			
Glamis Road (S)	Ahead	126	51%	56%	63%	4	4	5	70	72	76			
	Right Left		68%	68%	68%	19	19	19	18	18	18			
The Highway (W)	Left Ahead	840	68%	68%	68%	19	19	19	18	17	17			
	Ahead Right		63%	63%	63%	18	18	18	17	17	17			
			Practical Reserve Capacity (PRC)						Total Delay (PCU Hours)					
Overall junction performance			-15.1%	-15.7%	-16.4%				87	92	98			

Notes: DoS represents Degree of Saturation; the ratio of flow to capacity. MMQ represents Mean Maximum Queue for the busiest-case 15 minute modelled period (in vehicle lengths). Delay represents the mean delay per PCU. PCU represents Passenger Car Unit. PRC represents Practical Reserve Capacity; measure of how much additional traffic could pass through a junction whilst maintaining a maximum DoS of 90% on all lanes. PCU value for a car is one PCU. Vans and three-axle vehicles are 1.5 PCUs, vehicles with four or more axles are 2.3 PCUs. Buses and coaches are two PCUs. Motorcycles are 0.4 PCUs and pedal cycles are 0.2 PCUs. Thames Tideway Tunnel construction vehicles would be a mixture of three- and four-axle vehicles and have therefore been given a PCU value of two.

Table 21.5.7 Sensitivity testing case LinSig model outputs (PM peak hour)

		Weekday									
		PM peak hour (17:00-18:00)									
Approach	Arm	Flow (PCU)	DoS			MMQ (PCU)			Delay (seconds per PCU)		
			Base case	Devt case	Sen. case	Base case	Devt case	Sen. case	Base case	Devt case	Sen. case
Glamis Road (N)	Left Ahead	102	47%	44%	44%	4	4	4	64	62	62
	Right										
The Highway (E)	Left Ahead	972	97%	99%	100%	40	45	47	60	73	78
	Right Ahead	971	100%	101%	101%	46	50	51	83	90	94
Glamis Road (S)	Ahead Right Left	248	104%	102%	108%	18	17	23	225	201	273
The Highway (W)	Left Ahead	1046	90%	92%	92%	35	36	36	36	39	39
	Ahead Right	1046	84%	85%	85%	30	31	31	28	30	30
			Practical Reserve Capacity (PRC)						Total Delay (PCU Hours)		
Overall junction performance			-15.6%	-13.8%	-20.1%				73	79	87

Notes: DoS represents Degree of Saturation; the ratio of flow to capacity. MMQ represents Mean Maximum Queue for the busiest-case 15 minute modelled period (in vehicle lengths). Delay represents the mean delay per PCU. PCU represents Passenger Car Unit. PRC represents Practical Reserve Capacity; measure of how much additional traffic could pass through a junction whilst maintaining a maximum DoS of 90% on all lanes. PCU value for a car is one PCU. Vans and three-axle vehicles are 1.5 PCUs, vehicles with four or more axles are 2.3 PCUs. Buses and coaches are two PCUs. Motorcycles are 0.4 PCUs and pedal cycles are 0.2 PCUs. Thames Tideway Tunnel construction vehicles would be a mixture of three- and four-axle vehicles and have therefore been given a PCU value of two.

- 21.5.88 The sensitivity testing model indicates that the local highway will be operating over capacity in the AM peak and PM peaks without the Thames Tideway Tunnel proposals.
- 21.5.89 With inclusion of the construction traffic generated the sensitivity testing case indicates that the local highway will remain over capacity in the AM peak and PM peaks.
- 21.5.90 There is slight increase in demand resulting from the construction traffic. This affected the AM peak performance by increasing the degree of saturation by 7% on the Glamis Road northbound approach, one additional car length and an additional delay of 4 seconds per vehicle. It has also increased the queue by three vehicle lengths for The Highway (A1203) right ahead westbound approach, and additional delay of eight seconds. The majority of vehicles undertaking these movements would be associated with the construction traffic.
- 21.5.91 This affected the PM peak performance by increasing the queue on The Highway (A1203) right ahead westbound approach by one car length and increasing delay by four seconds per vehicle. It has also increased the queue by two vehicle lengths for The Highway (A1203) left ahead westbound approach, and additional delay of five seconds. The majority of vehicles undertaking these movements would be associated with the construction traffic.
- 21.5.92 The LinSig junction model output shows that total junction delay is 98 PCU hours in the AM peak period assessed and 87 PCU hours in the PM peak period assessed. These equate to 85 seconds per PCU in the AM peak period assessed and 71 seconds per PCU in the PM peak period assessed.

21.6 Operational assessment

- 21.6.1 This section summarises the findings of the assessment undertaken for Year 1 of operation at the King Edward Memorial Park Foreshore site.
- 21.6.2 The assessment of the operational phase is therefore limited to the physical issues associated with accessing the site from the highway network as outlined in Section 21.2. This has been discussed with the LB of Tower Hamlets and Transport for London.

Operational base case

- 21.6.3 The operational assessment year for transport is Year 1 of operation.
- 21.6.4 As explained in para 21.2.35, the elements of the transport network that would be affected during operation are highway layout and operation and parking. For the purposes of the operational base case, it is anticipated that the highway layout and parking will be as indicated in the construction base case.

Operational development case

- 21.6.5 The operational assessment has taken into consideration those elements that would be affected, which comprise the short term changes to the

highway layout and operation when maintenance visits are made to the site.

- 21.6.6 The assessment of the operational phase is therefore limited to the physical issues associated with accessing the site from the highway network, ie, highway layout and operation, as outlined in the following section. This has been discussed with the LB of Tower Hamlets and TfL.
- 21.6.7 The transport demands created by the development in the operational phase would be extremely low and limited to occasional maintenance visits every three to six months and larger cranes and associated support vehicles required for access to the shaft and tunnel every ten years.
- 21.6.8 As outlined in section 21.2, during the operational phase, access for maintenance vehicles would be required which would mean a change to the current layout. The highway layout during operation plans provided in the King Edward Memorial Park Foreshore *Transport Assessment* figures show the highway layout for the operational phase.

Parking

- 21.6.9 No change is expected to car parking in the vicinity of the site, compared to the base case, as a result of the operational phase arrangements at the site.
- 21.6.10 When cranes are required to service the site some car parking bays on Glamis Road would have to be temporarily suspended to ensure the vehicles have sufficient space to manoeuvre into the site. This temporary suspension would be on an infrequent basis and would occur approximately every ten years.
- 21.6.11 Taking into consideration the infrequent and temporary nature of the arrival of vehicles at the site which would require parking suspension, it is anticipated that there is unlikely to be a significant change to coach parking provision and activity in the area.

Highway layout and operation

- 21.6.12 An assessment has been undertaken to ensure that the highway layout provided is adequate for the large vehicles required to access the site during the operational phase. Swept paths have been undertaken for the largest vehicles including an 11.36m mobile crane, 10m articulated vehicle and 10.7m articulated vehicle. The swept path movements plans in the King Edward Memorial Park Foreshore *Transport Assessment* figures indicates the swept path movements during operation.
- 21.6.13 As identified above, as a result of the large turning circles of the cranes, some parking bays on Glamis Road would have to be suspended to ensure the vehicles have sufficient space to manoeuvre into the site. This would be approximately every ten years.
- 21.6.14 When larger vehicles are required to service the site, there may be some temporary, short-term delay to other road users while manoeuvres are made. However it is anticipated that the arrival of large vehicles would normally be scheduled to take place outside of the peak hours to minimise the effect on the local highway network.

- 21.6.15 Due to the infrequent nature of maintenance trips there is anticipated to be no significant change to the surrounding highway network during the operational phase at the site.

21.7 Summary of site-specific TA

- 21.7.1 The outcomes of this *Transport Assessment* demonstrate the key findings indicated in Table 21.7.1.

Table 21.7.1 King Edward Memorial Park Foreshore Transport Assessment results

Phase	Mode of transport	Key Findings
Construction	Pedestrians	<p>Approximately two minute 20 second delay to pedestrian journeys due to 180m diversion. Pedestrians using the eastern footway of Glamis Road would also have to cross the site access, leading to a slightly increased risk of accidents occurring. Appropriate management and signage would be provided to minimise this increased risk.</p>
	Cyclists	<p>Slight additional delay (maximum of 40 seconds) experienced by cyclists using the Thames Path as a result of the diversion of the Thames Path during construction.</p>
	Bus patronage and operators	<p>Approximately three additional two-way worker trips would be made by bus during the AM and PM peak hours which could be accommodated on base case bus services. A delay of a maximum of 13 seconds to bus services would be anticipated due to highway network delay.</p>
	DLR and National Rail patronage	<p>Approximately 31 worker trips would be made by DLR, London Overground or National Rail in each of the AM and PM peak hours and these could be accommodated on base case services.</p>
	River passenger services and patronage	<p>There are no river passenger services in the immediate vicinity of the site.</p>
	River navigation	<p>There would be a maximum of approximately four barge movements a day which is not anticipated to alter existing river navigation patterns.</p>
	Parking	<p>15m of on-street car parking will be suspended on Glamis Road; there is sufficient spare capacity elsewhere in the vicinity of the site to accommodate displaced demand.</p>
	Highway network and operation	<p>The stop line and advanced cycle stop line on the Glamis Road arm of the Glamis Road / The Highway (A1203) would be relocated. The existing access to the Park on Glamis Road would be widened and a crossover would be constructed. Dropped kerbs and tactile paving would be provided. The site access would be gated for the left-turn in/right-turn out movement.</p>

Transport Assessment

Phase	Mode of transport	Key Findings
		Approximately 118 additional daily vehicle movements would be produced by the construction works at the site.
Operation	Parking	No change expected to car parking in the vicinity of the site compared to the construction phase.
	Highway layout and operation	Some network delay may be experienced by other road users when large vehicles are accessing the site; however this would take place outside of the peak hours and would be infrequent and temporary.

References

¹ Transport for London, *Travel Planning for new development in London*, Transport for London (2011).

² Assessment Tool for Travel plan Building Testing and Evaluation, (*ATTrBuTE*), is a web-based travel planning tool, which ensures that Travel Plans are in accordance with TfL's published guidance on travel planning for new development in London. Available at: <http://www.attrbute.org.uk/>.

³ Department for Transport (DfT), *Traffic Signs Manual Chapter 8 - Traffic Safety Measures and Signs for Road Works and Temporary Situations*, 2009.

⁴ Department for Transport (DfT), 2009. See citation above.

⁵ *HM Government, Equality Act 2010 – Guidance, 2010.*

⁶ Department for Transport (DfT), 2009. See citation above.

⁷ Department for Transport (DfT), *Traffic Advisory Leaflet 15/99 – Cyclists at Road Works, December 1999.*

Thames Tideway Tunnel
Thames Water Utilities Limited



Application for Development Consent

Application Reference Number: WWO10001

Transport Assessment

Doc Ref: **7.10.18**

King Edward Memorial Park Foreshore

Appendices

APFP Regulations 2009: Regulation **5(2)(q)**

Hard copy available in

Box **52** Folder **B**
January 2013

**Thames
Tideway Tunnel**



Creating a cleaner, healthier River Thames

This page is intentionally blank

Thames Tideway Tunnel

Transport Assessment

Section 21 Appendices: King Edward Memorial Park Foreshore

List of contents

	Page number
Appendix A : Policy review	1
A.1 Introduction	1
A.2 National Policy	1
A.3 Regional policy	3
A.4 Local policy	6
Appendix B : PTAL analysis.....	12
Appendix C : Local modelling outputs.....	15
C.1 Baseline results, AM peak hour.....	15
C.2 Baseline results, PM peak hour.....	19
C.3 Construction base case results, AM peak hour	24
C.4 Construction base case results, PM peak hour	28
C.5 Construction development case results, AM peak hour	33
C.6 Construction development case results, PM peak hour	37
C.7 Construction development case results, 'all by road' sensitivity test, AM peak hour	42
C.8 Construction base case results, 'all by road' sensitivity test, PM peak hour.....	47
Appendix D : Accident analysis	52
D.1 Existing highway safety analysis	52
D.2 Summary and conclusion	54
Appendix E : Road Safety Audit	55

This page is intentionally blank

Appendix A: Policy review

A.1 Introduction

- A.1.1 There are a number of documents containing planning policies that are relevant to transport matters for the proposed development at King Edward Memorial Park. This includes national, regional and local policies relevant to the site.
- A.1.2 This section reviews current documents relevant to the proposed development which is situated within the Royal Borough (RB) of Kensington and Chelsea.

A.2 National Policy

National Planning Policy Framework (March 2012)

- A.2.1 The Department for Communities and Local Government published the National Planning Policy Framework (NPPF) in March 2012. The NPPF replaces a variety of existing planning guidance, most notable the following document, Planning Policy Guidance 13: Transport (November 2010).
- A.2.2 The key objective of the NPPF is to create a policy context to support economic growth. The principle of the guidance is to place an emphasis on sustainable development, where environmental conditions should be considered alongside economical and social matters.
- A.2.3 It outlines the importance of local development plans and notes that where development accords with an up to date development plan then the proposals should be approved. Moreover, it suggests that local authorities should follow the approach of the presumption in favour of sustainable development.
- A.2.4 With particular reference to transport matters the documents states:
“In preparing local plans, local planning authorities should therefore support a pattern of development which, where reasonable to do so, and facilitates the use of sustainable modes of transport.”
- A.2.5 The guidance goes on to advise at paragraph 32:
“All developments that generate significant amounts of movement should be supported by a Transport Statement or Transport Assessment. Plans and decisions should take account of whether:
- the opportunities for sustainable transport modes have been taken up depending on the nature and location of the site, to reduce the need for major transport infrastructure;*
 - safe and suitable access to the site can be achieved for all people; and*
 - improvements can be undertaken within the transport network that cost effectively limit the significant impacts of the development.*

Development should only be prevented or refused on transport grounds where the residual cumulative impacts of development are severe.”

A.2.6 The document also states that:

“Plans should protect and exploit opportunities for the use of sustainable transport modes for the movement of goods or people”. Therefore:

“A key tool to facilitate this would be a Travel Plan. All developments which generate significant amounts of movement should be required to provide a Travel Plan”.

National Policy Statement for Waste Water (March 2012)

A.2.7 The National Policy Statement for Waste Water (NPS) was published by the Department of Environment, Food and Rural Affairs in March 2012. This National Policy Statement (NPS) sets out Government policy for the provision of major waste water infrastructures. The NPS does not recognise the Thames Tideway Tunnel project within the original thresholds which is contained within the Planning Act. However the document indicates that *“the Government has already stated its intention that the project should be considered at a national level”.*

A.2.8 The Secretary of State announced that development consent for the Thames Tideway Tunnel project should also be dealt with under the regime for nationally significant infrastructure projects under the Planning Act 2008.

A.2.9 The NPS seeks a sustainable long term solution to address the untreated sewage discharged into the river Thames and Thames Tideway Tunnel has been considered as the preferred solution.

A.2.10 With particular reference to transport matters the document states:
“The ES should include a transport assessment, using the NATA/WebTAG methodology stipulated in Department for Transport (DfT), or any successor to such methodology. Applicants should consult the Highways Agency and/or the relevant highway authority, as appropriate, on the assessment and on mitigation measures. The assessment should distinguish between the construction, operation and decommissioning project stages as appropriate”.

A.2.11 The document states that the impacts on the surrounding transport infrastructure should be mitigated and where the mitigation measures are not sufficient the requirements to mitigate adverse impacts on transport networks should be considered.

A.2.12 Therefore it is advised to prepare a travel plan which includes demand management measures to mitigate transport impacts, and *“to provide details of proposed measures to improve access by public transport, walking and cycling, to reduce the need for parking associated with the proposal and to mitigate transport impacts”.*

A.2.13 The NPS prefers water-borne or rail transport over road transport and where there is likely to be substantial HGV traffic, the following measures should be looked:

- “control numbers of HGV movements to and from the site in a specified period during its construction and possibly on the routing of such movements;
- make sufficient provision for HGV parking, either on the site or at dedicated facilities elsewhere, to avoid ‘overspill’ parking on public roads, prolonged queuing on approach roads and uncontrolled on-street HGV parking in normal operating conditions; and
- ensure satisfactory arrangements for reasonably foreseeable abnormal disruption, in consultation with network providers and the responsible police force”.

A.2.14 The proposed development is located at a relatively moderate accessible transport hub and the proposed location has a Public Transport Accessibility Level (PTAL) rating of 3, rated as ‘moderate’. It is assumed that construction workers would not travel by car to and from the site on the basis that there would be no worker parking on site; on-street parking in the area is restricted; and site-specific Travel Plan measures will discourage workers from travelling by car. Information regarding the travel arrangements of the workers associated with the site will be included in the *Draft Project Framework Travel Plan* which accompanies this application.

A.3 Regional policy

The London Plan (July 2011)

A.3.1 The London Plan 2011 is produced by the Greater London Authority (GLA) and sets out the strategic planning guidance for London planning authorities. The Mayor of London is responsible for strategic planning and the production of a Spatial Development Strategy called The London Plan. The London plan sets out the integrated economic, environmental, transport and social framework for the development of London over the next 20-25 years. The Plan takes the year 2031 as its formal end date and its over-arching vision is supported by six detailed objectives for London:

- A city that meets the challenges of economic and population growth;
- An internationally competitive and successful city;
- A city of diverse, strong, secure and accessible neighbourhoods;
- A city that delights the senses;
- A city that becomes a world leader in improving the environment; and
- A city where it is easy, safe and convenient for everyone to access jobs, opportunities and facilities.

A.3.2 The last objective of the plan relates specifically to transport. Policies within the London Plan of relevance to the proposed development are outlined as follows:

- A.3.3 **Policy 6.1 – Strategic Approach** advises that the mayor will work with all relevant partners to encourage the closer integration of transport and development by:
- Encouraging patterns and nodes of development that reduce the need to travel, especially by car;
 - Seeking to improve the capacity and accessibility of public transport, walking and cycling, particularly in areas of greater demand;
 - Supporting development that generates high levels of trips at locations with high public transport accessibility and/or capacity, either currently or via committed, funded improvement;
 - Seeking to increase the use of the Blue Ribbon Network, especially the Thames, for passenger and freight use;
 - Facilitating the efficient distribution of freight whilst minimising its impacts on the transport network;
 - Supporting measures that encourage shifts to more sustainable modes and appropriate demand management; and
 - Promoting greater use of low carbon technology so that carbon dioxide and other contributors to global warming are reduced.
- A.3.4 **Policy 6.2 – Providing public transport capacity and safeguarding land for transport** which notes that development proposals that do not provide adequate safeguarding for the schemes should be refused.
- A.3.5 **Policy 6.3 – Assessing effects of development on transport capacity** outlines that development proposals should ensure that impacts on transport capacity and the transport network, at both a corridor and local level, are fully assessed. Development should not adversely affect safety on the transport network. Where existing transport capacity is insufficient for the travel generated by proposed developments, and no firm plans exist for an increase in capacity, boroughs should ensure that the development proposals are phased until it is known that these requirements can be met. The policy notes that the use of Travel Plans and addressing freight issues can help reduce the impact of development on the transport network.
- A.3.6 **Policy 6.7 – Better streets and surface transport** notes that high levels of priority should be provided to bus routes and there should be direct, secure, accessible and pleasant walking routes to stops. The development would include provision of transport to and from public transport nodes where sites are at a distance from public transport services.
- A.3.7 **Policy 6.9 – Cycling** presents measures to increase cycling mode share in London to 5 percent by 2026. Measures include completing the Cycle Super Highways and expanding the London cycle hire scheme. To support this, developments should provide cycle parking to at least the minimum standards, provide showers and changing facilities and facilitate the major cycling schemes in London (Super Highways / Cycle Hire).

- A.3.8 **Policy 6.10 – Walking** recommends the use of shared space principles with simplified streetscape, de-cluttering and access for all. Developments should therefore ensure high quality pedestrian environments and emphasise the quality of pedestrian and street space. It points to the ‘Legible London’ pedestrian wayfinding system as a successful measure to support walking journeys.
- A.3.9 **Policy 6.13 – Parking** outlines the need to seek an appropriate balance between promoting new development and preventing excessive car parking provision that can undermine cycling, walking and public transport use. As such, car parking should reduce as public transport accessibility (measured by PTAL) increases. The policy advises that Transport assessments and travel plans for major developments should give details of proposed measures to improve non-car based access, reduce parking and mitigate adverse transport impacts.
- A.3.10 **Policy 6.14 – Freight** notes that freight distribution should be improved and movement of freight by rail and waterway should be promoted. To support this, developments that generate high number of freight movements should be located close to major transport routes. In addition, the Freight Operators Recognition Scheme, construction logistics plans and delivery and servicing plans should be promoted. The policy also advises the increase in the use of the Blue Ribbon Network for freight transport.

The Mayors Transport Strategy (GLA, 2010)

- A.3.11 In addition to the London Plan, the Mayor has prepared a number of strategies that are essentially an extension of the London Plan. Published by the GLA in 2010, the Mayor’s Transport Strategy (MTS) (Greater London Authority, May 2010) envisages *“London’s Transport system excelling among that of global cities, providing access to opportunities for all people and enterprises while achieving the highest environmental standards and leading the world in its move towards tackling the urban transport challenges of the 21st century”*.
- A.3.12 The MTS sets out a number of policy commitments or requirements which have implications for TfL and a range of other delivery partners including the GLA and the London boroughs. The policies that are relevant to the proposed development are:
- **Policy 4** indicating that the Mayor will seek *“to improve people’s access to jobs, business’ access to employment markets, business to business access, and freight access by seeking to ensure appropriate transport capacity and connectivity is provided on radial corridors into central London”*;
 - **Policy 5** seeks *“to ensure efficient and effective access for people and goods within central London”*;
 - **Policy 8** supports *“a range of transport improvements within metropolitan town centres for people and freight that help improve connectivity and promote the vitality and viability of town centres, and that provide enhanced travel facilities for pedestrians and cyclists”*;

- **Policy 9** states that the Mayor “*will use the local and strategic development control processes*”;
- **Policy 11** specifies that the Mayor will “*encourage the use of more sustainable, less congesting modes of transport, set appropriate parking standards, and aim to increase public transport, walking and cycling mode share*”;
- **Policy 12** states that the Mayor “*will seek to improve the distribution of freight through the provision of better access to/from Strategic Industrial Locations, delivery and servicing plans, and other efficiency measures across London*”; and
- **Policy 15** and **Policy 16** indicate that the Mayor will seek to reduce emissions of air pollutants and noise impacts from transport respectively.

A.3.13 The *London Freight Plan, Sustainable Freight Distribution: a Plan for London* (TfL, June 2008) sets out the steps that have to be taken over the next five to ten years to identify and begin to address the challenge of delivering freight sustainably in the capital. Principles set in that document are expected to be relevant to the consideration of the construction logistics strategy for the proposed development.

A.4 Local policy

A.4.1 The London Borough of Tower Hamlets has a number of policies relevant to transport within the Local Development Framework (LDF), the Unitary Development Plan (UDP), the Development Control Plan Interim Planning Guidance (IPG) and within Supplementary Planning Guidance (SPG) and Advice documents.

Local Development Framework - Core Strategy (LB of Tower Hamlets, September 2010)

A.4.2 The emerging LDF aims to guide and manage development and regeneration in the borough until 2025. The Core Strategy of the LDF, adopted in September 2010, now forms part of the statutory planning guidance for the borough, together with the IPG and the saved policies of the UDP.

A.4.3 Transport policies within the Core Strategy focus on ensuring improvements are made to the environment and open spaces, reducing carbon emissions, encouraging the use of sustainable transport and interconnecting within the borough.

A.4.4 **Policy SO1- Delivering Tower Hamlets’ regional role** requires that all large developments maximise the social benefits for the borough and help to ensure that the “*borough develops as a sustainable, liveable and healthy area of inner London.*”

A.4.5 **Policy SO3 - Achieving wider sustainability** states that any existing or new infrastructure should enhance health benefits (such as providing access to open spaces), reduce development related carbon emissions, protect and enhance the natural environment by reducing land, air, noise

and water pollution and ensure that the capacity of new development is sufficient to support growth.

- A.4.6 **Policy SP03 - Creating healthy and liveable neighbourhoods** aims to achieve active and healthy lifestyles by providing quality walking and cycling networks, promoting sustainable modes of travel and reducing noise and air pollution in the borough.
- A.4.7 **Policy SP04 - Creating a Green and Blue grid** identifies how existing and new green and blue spaces should be protected, developed and enhanced to create connected and publically accessible areas.
- A.4.8 **Policy SO14 - Dealing with Waste** outlines the borough's plan to manage and minimise waste, reducing the amount that is sent to landfill.
- A.4.9 **Policy SP05 - Dealing with Waste** categorizes the waste management hierarchy of reuse, recycle and reduce and requires all developments to reduce and reuse waste from construction and demolition.
- A.4.10 **Policy SO20 - Creating attractive and safe streets and spaces** requires that streets and spaces are well designed, safe, attractive and accessible by sustainable modes of travel.
- A.4.11 **Policy SO21 - Creating attractive and safe streets and spaces** aims to create places and spaces that promote social inclusion and interaction.
- A.4.12 **Policy SP09 - Creating attractive and safe streets and spaces** recognises to put pedestrians first and *"promote streets, both as links as movements and places in their own right," "minimise on-street and off-street parking provision, particularly in areas of good public transport"* and ensure that *"new development has no adverse impact on the safety and capacity of the road network."*
- A.4.13 **Policy SO24 - Working towards a zero carbon borough** sets a target to *"achieve a zero carbon borough in the 21st century, with a 60% reduction in carbon emissions by 2025."*
- A.4.14 **Policy SP11 - Working towards a zero carbon borough** outlines the borough's strategy to reduce carbon emissions to meet the target set in Policy SO24.
- A.4.15 **Policy SO25 - Deliver place making** identifies the need to create distinctive and well-designed places which interconnect and integrate with the wider London area.
- A.4.16 **Policy SP12 - Deliver place making** identifies ways to improve, enhance and develop a network of sustainable, connected, and well designed areas across the borough.

Unitary Development Plan (LB of Tower Hamlets, December 1998)

- A.4.17 The UDP was adopted by the London Borough of Tower Hamlets in December 1998. Due to the emerging LDF and the adoption of the Core Strategy, a number of policies have been deleted from the UDP.
- A.4.18 The relevant transport policies set out in this document focus on environmental protection (including reducing levels of pollution within the

borough), the provision of strategic riverside walkways, sustainable travel, the use of waterways for freight and the borough's criteria for the development of public utilities and services.

A.4.19 The relevant UDP policies which have been saved since September 2007 are outlined below.

A.4.20 **Policy DEV2 – Environmental requirements** aims to reduce detrimental impacts of development on the environment by:

- Safeguarding the amenity of residents and the environment from the effects of pollution;
- Ensuring that adjoining buildings are not negatively affected by loss of privacy and the daylight and sunlight conditions;
- Protecting and enhancing areas of significance for nature conservation and sites of local importance; and
- Integrating sustainable development into development, such as incorporating energy efficient measures.

A.4.21 **Policy DEV48 – Strategic riverside walkways and new development** indicates that developments with a water frontage should “provide a walkway to an acceptable standard except where the walkway would conflict with commercial or transport interests.”

A.4.22 **Policy DEV49 – Moored vessels and structures** states that development incorporating moored vessels or structures within or over rivers, canals or dock areas will only be granted if it is fundamental to the movement of passengers/goods by water and/or if it would increase water recreational use.

A.4.23 **Policy DEV57 – Development affecting nature conservation areas** indicates that development should not be permitted where unnecessary harm would be caused to sites of conservation importance or the Green Chain.

A.4.24 **Policy DEV64 – Strategic riverside walkway designation** describes the Strategic Riverside Walkway.

A.4.25 **Policy DEV65 – Protection of existing walkways** specifies that existing walkways would be protected from development that would have an impact on existing access and character.

A.4.26 **Policy DEV66 – Creation of new walkways** identifies a network of pedestrian footpaths, with consideration to the Green Chains and the Strategic Riverside Walkway.

A.4.27 **Policy T16 – Traffic priorities for new development** focuses on the proposed operational use and the impact of development associated traffic. The borough will consider the development proposals in terms of:

- Danger or inconvenience to other road users such as pedestrians and cyclists;
- Emergency access obstruction;
- Detrimental impacts on the public transport network; and

- Negative impacts in the environment or residential/other sensitive areas.

A.4.28 **Policy T26 – Use of the waterways for freight** encourages “a maximum feasible use of the waterways for the movement of freight and bulky goods.”

A.4.29 **Policy U1 – Considerations regarding new public utility development.** This policy highlights the following criteria for the development of public utilities and services:

- *“The need for the service to be located in the borough,*
- *The likely effects of the operation upon traffic generation, pollution, noise and nuisance, and*
- *The likely effects of the operation upon residential amenity.”*

Core Strategy and Document Control Plan Interim Planning Guidance (LB of Tower Hamlets, October 2007)

A.4.30 The IPG was adopted by the London Borough of Tower Hamlets in October 2007. This document considers policies that have not yet been superseded by the Core Strategy. Policies within this document largely focus on accessibility, sustainable transport, transport assessments & travel plans.

A.4.31 **Policy DEV 3 - Accessibility and Inclusive Design** outlines the design requirements for new developments.

A.4.32 **Policy DEV 4 - Safety and security** outlines a number of safety and security measures that should be put in place to support new developments.

A.4.33 **Policy DEV 12- Management of Demolition and Construction** requires the submission of Demolition and Construction Environmental Management Plans to minimise the impact on local amenity.

A.4.34 **Policy DEV 16 - Walking and Cycling routes and facilities** aims to improve and enhance pedestrian and cycle facilities by integrating development with pedestrian and cycle routes, ensuring accessibility for all, providing cycle parking and changing facilities and maintaining and enhancing Strategic Walkways and the Tower Hamlets Cycle Network.

A.4.35 **Policy DEV 17 - Transport Assessments** requires developments to provide adequate and safe servicing and circulation proposals, identify the impact of the development on the transport network and provide appropriate mitigation where required, justify parking and promote sustainable travel.

A.4.36 **Policy DEV 18- Travel Plans** requires the submission of a Travel to support any major development.

A.4.37 **Policy OSN 3- Blue Ribbon Network and the Thames Policy Area** considers the impact of development on or next to the Blue Ribbon Network, including the Thames Policy Area. Policy requirements include:

- Appropriate access to the water and enjoyment for all;
- Proposals for moored vessels and structures should not interfere with navigation, create siltation issues, affect river walls and flood defences, cause accessibility issues or negatively impact on the amenity of nearby users;
- Proposals for non-residential moored vessels and structures in or over river, canal or dock areas will only be supported if they improve movement of goods and passengers and increase the recreational use; and
- Any major development adjacent to the Blue Ribbon Network, including developments within the Thames Policy Area, should be supported by an assessment covering impacts to access, permeability and biodiversity.

Supplementary Planning Guidance (SPG)

- A.4.38 The borough has a number of Supplementary Planning Guidance/Advice documents to support the Development Plan.
- A.4.39 Transport policies within the identified documents below are concerned with ensuring improvements are made to encouraging the use of sustainable transport, riverside waterways and river/canal transport within the borough.
- A.4.40 **Leaside Area Action Plan (LB of Tower Hamlets, October 2007)** aims to promote more sustainable transport, improve public transport within Leaside, encourage accessibility and movement and promote river transport use.
- A.4.41 **Riverside Walkways SPG (LB of Tower Hamlets, December 1998)** seeks to safeguard and promote the provision of walkways along the riverside.
- A.4.42 **Canalside Developments SPG (LB of Tower Hamlets, December 1998)** provides further guidance for designing developments along the borough's canals.
- A.4.43 **Limehouse Cut Conservation Area Statement and Appraisal Management Plan (LB of Tower Hamlets, April 2011)** outlines the management plan for the conservation of this designated area, which consists of the Limehouse Cut, the former Poplar Employment Exchange and industrial buildings located on Dod Street.
- A.4.44 **Wapping Wall Conservation Area Statement and Appraisal Management Plan (LB of Tower Hamlets, November 2009)** provides detail on the conservation and regeneration of this designated area. King Edward Memorial Park forms part of this conservation area. Focus is given to maintaining the character of the area and the preservation of trees and listed structures.
- A.4.45 **York Square Conservation Area Statement and Appraisal Management Plan (LB of Tower Hamlets, November 2009)** recognizes that "*Commercial Road is a busy road within York Square Conservation*

Area and indeed across the borough and is a principal route between the East End and City.” Emphasis is also placed on improving pedestrian and cycle lanes along this route and adjoining side streets.

This page is intentionally blank

Appendix B: PTAL analysis

This page is intentionally blank

PTAI Study Report File Summary

PTAI Run Parameters

PTAI Run 20122609155039
Description 20122609155039
Run by user PTAL web application
Date 26/09/2012

Walk File Parameters

Walk File PLSQLTest
Day of Week M-F
Time Period AM Peak
Walk Speed 4.8 kph
BUS Walk Access Time (mins) 8
BUS Reliability Factor 2.0
LU LRT Walk Access Time (mins) 12
LU LRT Reliability Factor 0.75
NATIONAL_RAIL Walk Access Time (mins) 12
NATIONAL_RAIL Reliability Factor 0.75
Coordinates: 535388, 180644

Transport Assessment

Mode	Stop	Route	Distance (metres)	Frequency (vph)	Weight	Walk time (mins)	SWT (mins)	TAT (mins)	EDF	AI
BUS	GLAMIS ROAD CABLE STREET	100	191.97	8	0.5	2.4	5.75	8.15	3.68	1.84
BUS	GLAMIS ROAD THE HIGHWAY	D3	53.28	6	1	0.67	7	7.67	3.91	3.91
LU LRT	Shadwell	Docklands Light Railway Bank to Lewisham DLR	742.28	15	1	9.28	2.75	12.03	2.49	2.49
NATIONAL RAIL	Wapping	WEST CROYDON to DALSTON	655.88	4	1	8.2	8.25	16.45	1.82	1.82
NATIONAL RAIL	Wapping	NEW CROSS to HIGHBURY AND ISLINGTON	655.88	4	0.5	8.2	8.25	16.45	1.82	0.91
NATIONAL RAIL	Wapping	CRYSTAL PALACE to HIGHBURY AND ISLINGTON	655.88	4	0.5	8.2	8.25	16.45	1.82	0.91

Total AI for this POI is 11.88.
PTAL Rating is 3.

Appendix C: Local modelling outputs

C.1 Baseline results, AM peak hour

Network Layout Diagram

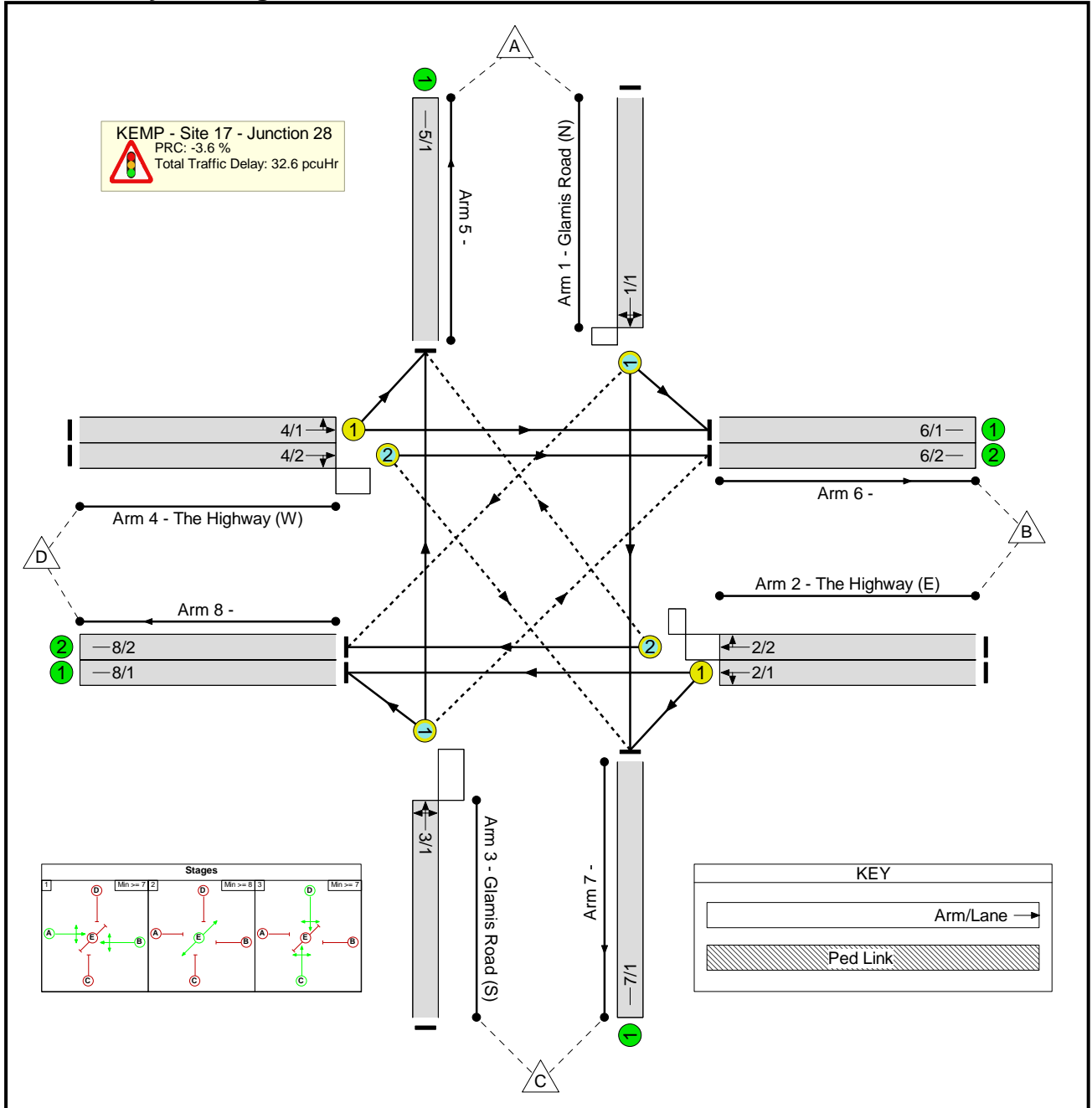

Phase Diagram

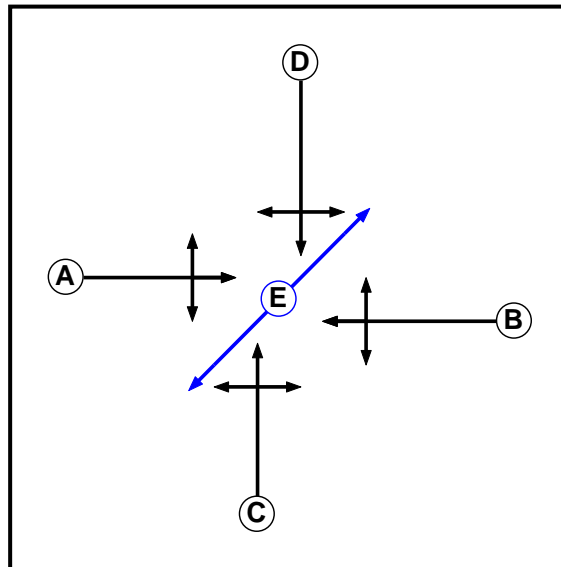

Stage Diagram

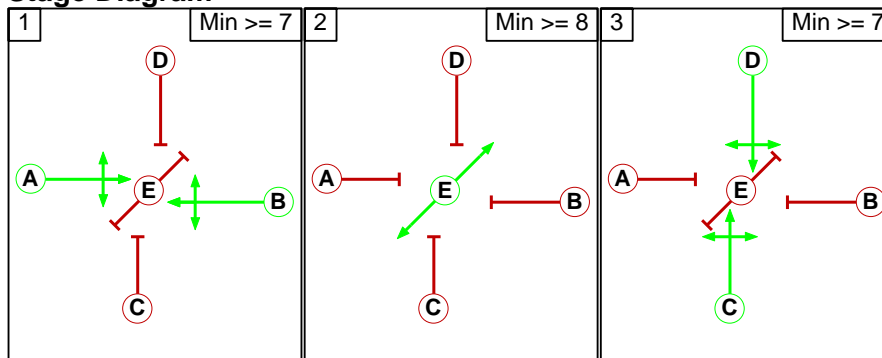

Phases in Stage

Stage No.	Phases in Stage
1	A B
2	E
3	C D

Phase Intergreens Matrix

		Starting Phase				
		A	B	C	D	E
Terminating Phase	A	-	6	7	9	
	B	6	-	6	7	9
	C	6	6	-	11	
	D	6	6	-	11	
	E	15	15	15	15	

Traffic Flows, Desired

Desired Flow :

		Destination				
		A	B	C	D	Tot.
Origin	A	0	25	35	32	92
	B	14	0	257	1703	1974
	C	9	82	0	2	93
	D	26	1484	2	0	1512
	Tot.	49	1591	294	1737	3671

Signal Timings Diagram

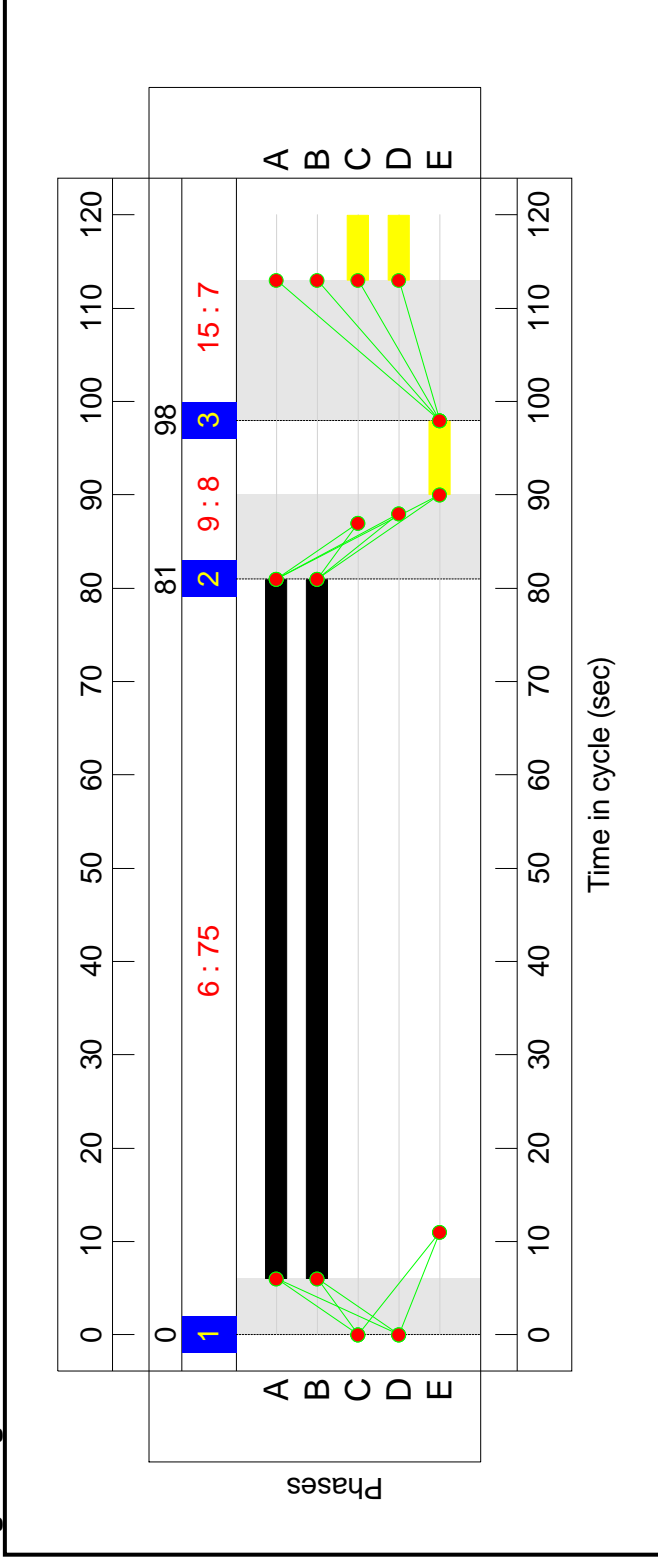

Network Results

Item	Lane Description	Full Phase	Demand Flow (pcu)	Deg Sat (%)	Av. Delay Per PCU (s/pcu)	Mean Max Queue (pcu)	
1/1	Glamis Road (N) Left Ahead Right	D	92	44.8%	65.2	3.2	
2/1	The Highway (E) Left Ahead	B	987	93.2%	40.7	35.2	
2/2	The Highway (E) Right Ahead	B	987	93.2%	41.3	35.2	
3/1	Glamis Road (S) Ahead Right Left	C	93	46.1%	67.8	3.3	
4/1	The Highway (W) Left Ahead	A	756	61.2%	16.4	15.5	
4/2	The Highway (W) Ahead Right	A	756	56.8%	15.4	14.7	
C1		PRC for Signalled Lanes (%): PRC Over All Lanes (%)	-3.6 -3.6	Total Delay for Signalled Lanes (pcuHr): Total Delay Over All Lanes (pcuHr)	32.58 32.58	Cycle Time (s):	120

C.2 Baseline results, PM peak hour

Network Layout Diagram

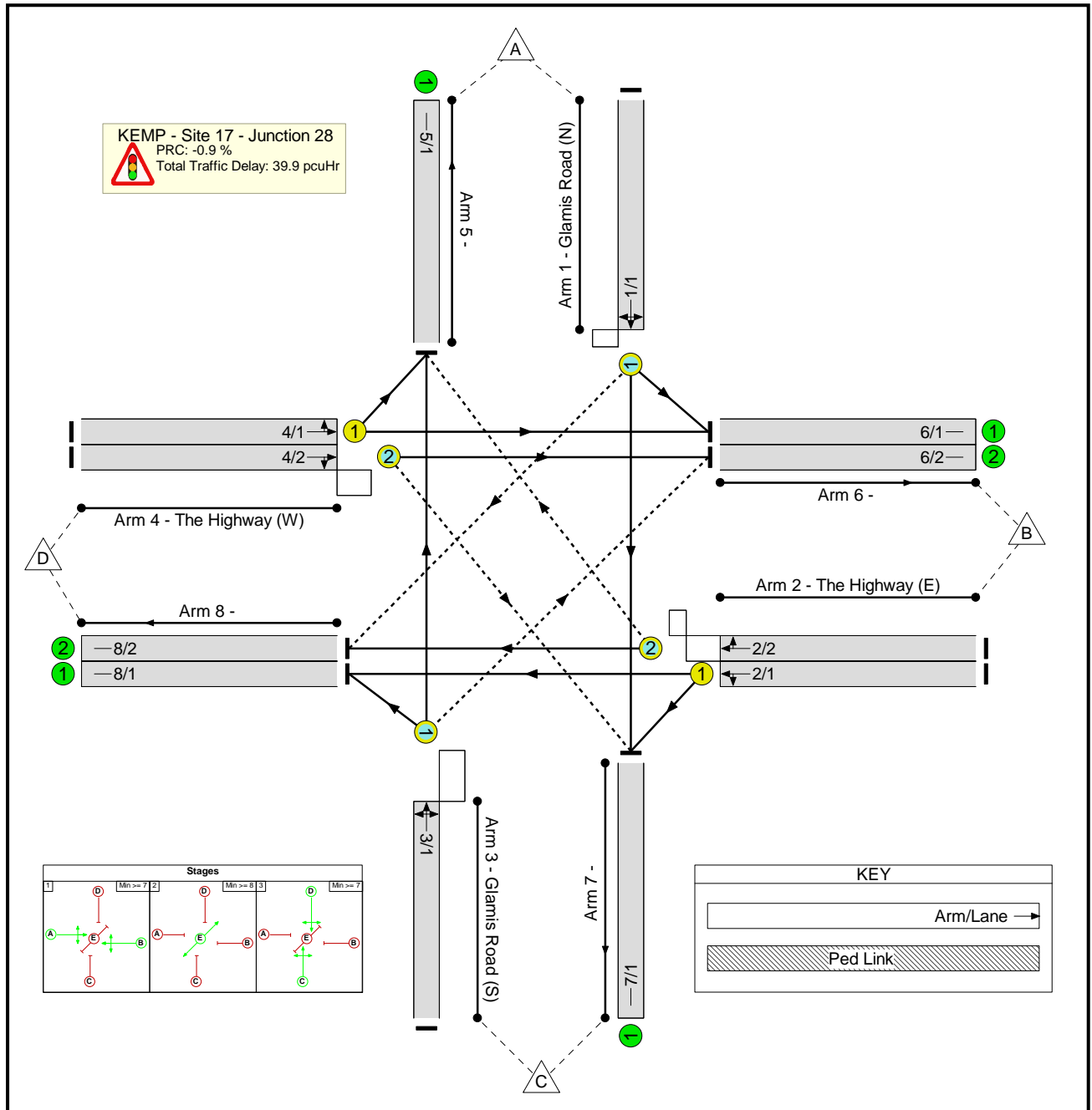

Phase Diagram

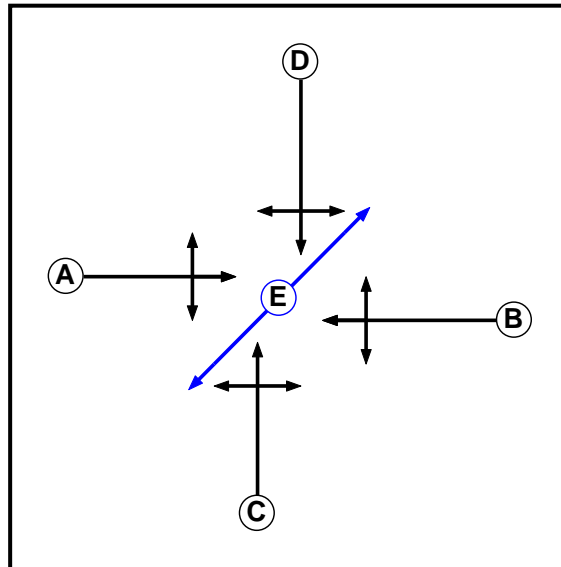

Stage Diagram

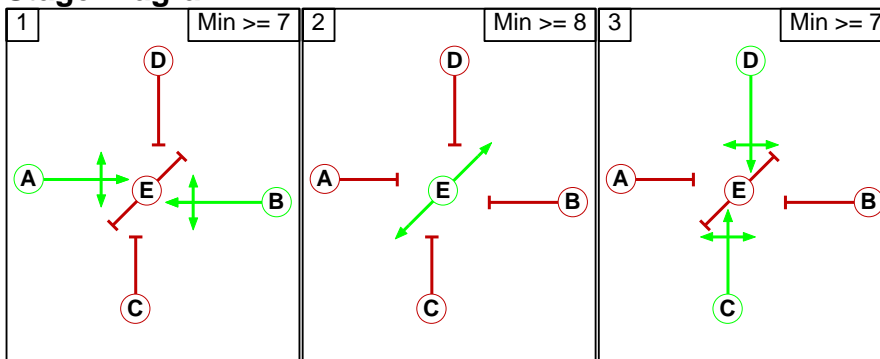

Phases in Stage

Stage No.	Phases in Stage
1	A B
2	E
3	C D

Phase Intergreens Matrix

		Starting Phase				
		A	B	C	D	E
Terminating Phase	A	-	6	7	9	
	B	6	-	6	7	9
	C	6	6	-	11	
	D	6	6	-	11	
	E	15	15	15	15	

Traffic Flows, Desired

Desired Flow :

		Destination				
		A	B	C	D	Tot.
Origin	A	0	43	27	22	92
	B	29	0	111	1588	1728
	C	12	186	0	4	202
	D	18	1861	2	0	1881
	Tot.	59	2090	140	1614	3903

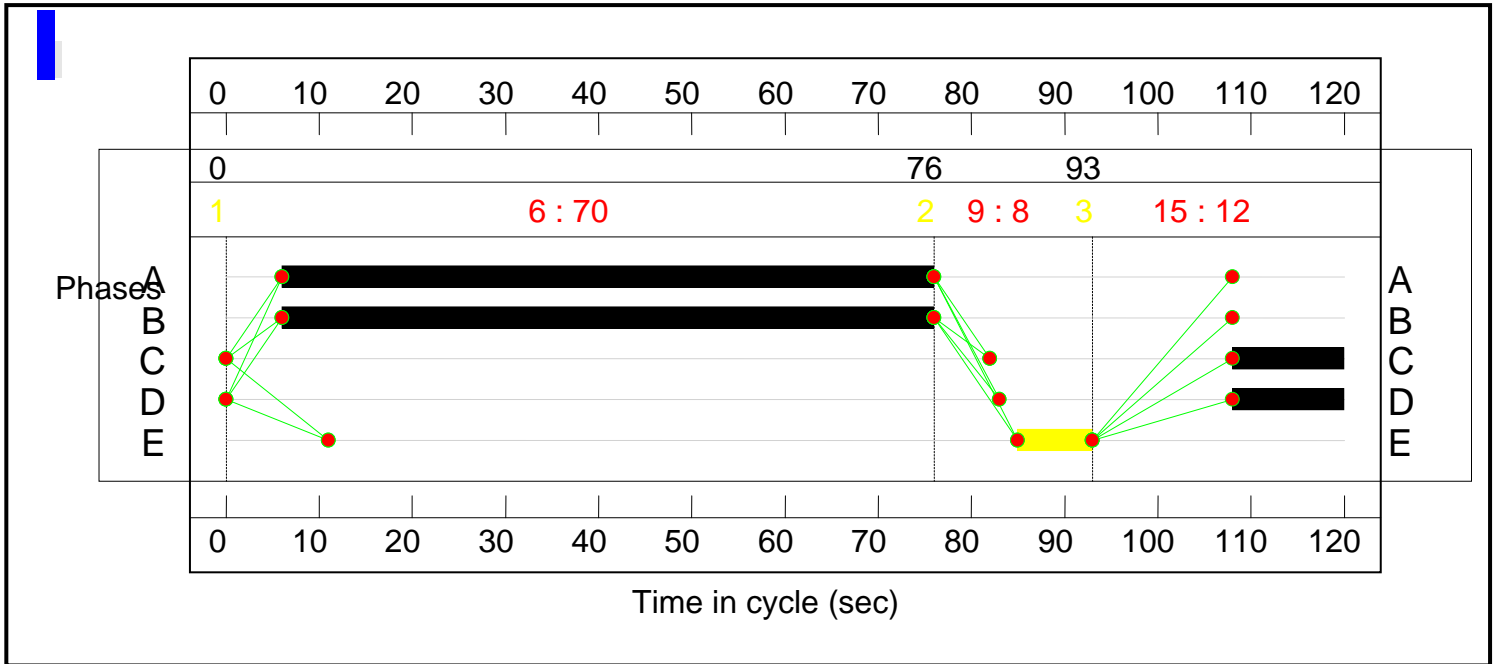

Signal Timings Diagram

Network Results

Item	Lane Description	Full Phase	Demand Flow (pcu)	Deg Sat (%)	Av. Delay Per PCU (s/pcu)	Mean Max Queue (pcu)
1/1	Glamis Road (N) Left Ahead Right	D	92	39.7%	60.5	3.1
2/1	The Highway (E) Left Ahead	B	864	88.5%	36.1	28.1
2/2	The Highway (E) Right Ahead	B	864	90.8%	41.0	29.0
3/1	Glamis Road (S) Ahead Right Left	C	202	88.0%	106.9	9.6
4/1	The Highway (W) Left Ahead	A	941	82.4%	28.3	27.1
4/2	The Highway (W) Ahead Right	A	940	76.6%	24.6	24.9
		C1	PRC for Signalled Lanes (%): PRC Over All Lanes (%)	-0.9 -0.9	Total Delay for Signalled Lanes Total Delay Over All Lanes	

C.3 Construction base case results, AM peak hour

Network Layout Diagram

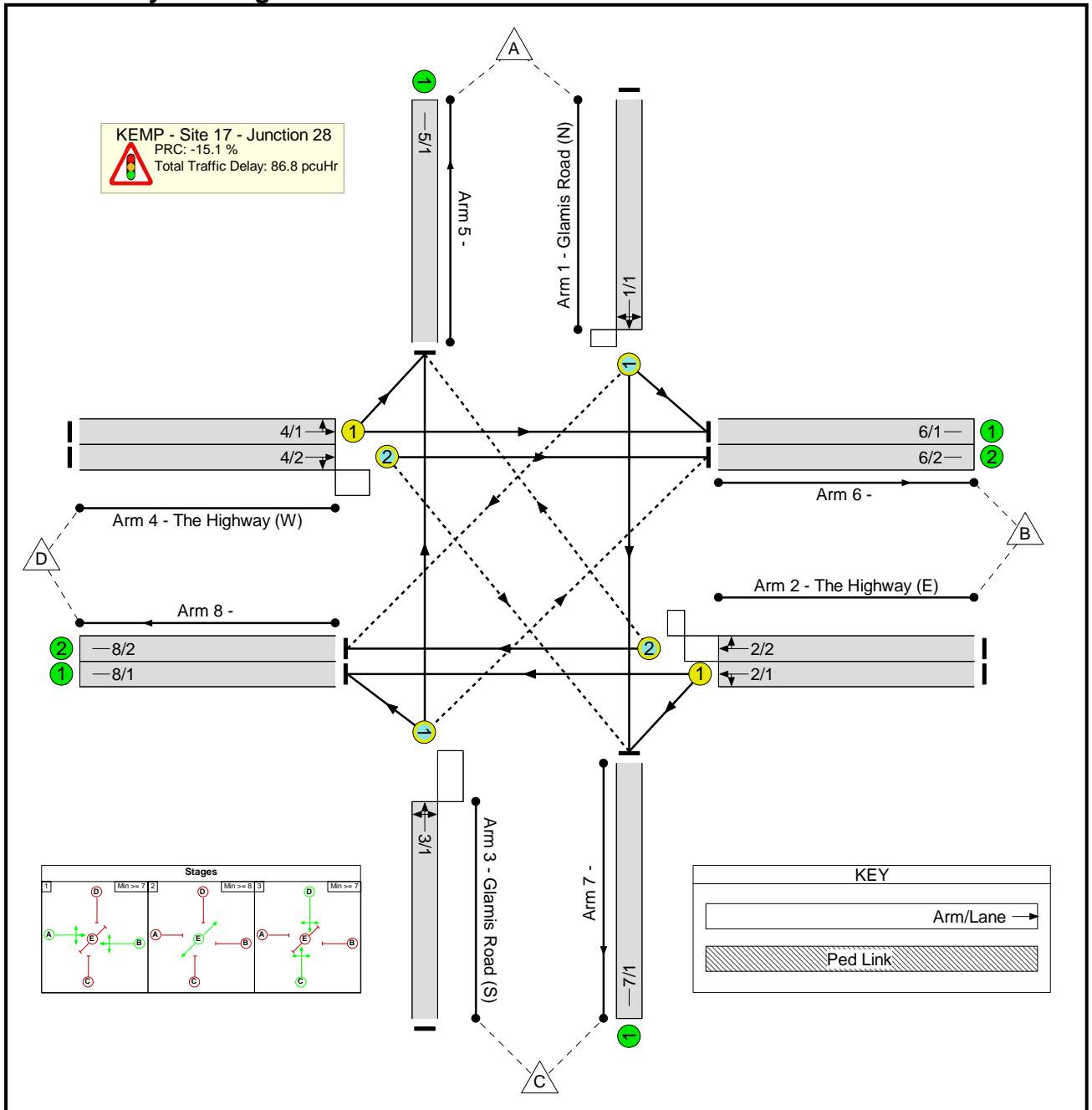

Phase Diagram

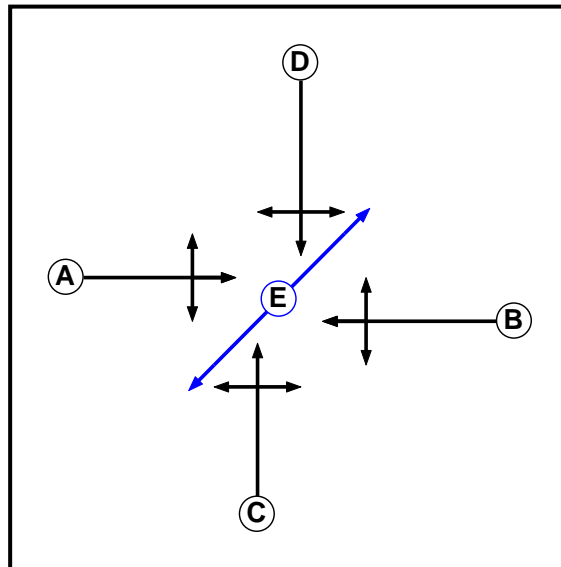

Stage Diagram

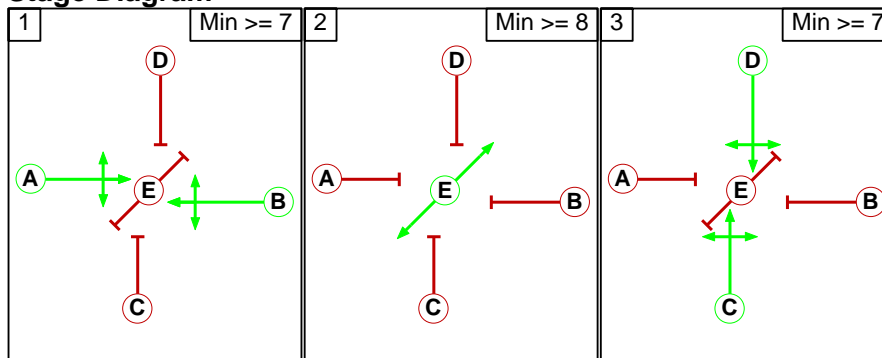

Phases in Stage

Stage No.	Phases in Stage
1	A B
2	E
3	C D

Phase Intergreens Matrix

		Starting Phase				
		A	B	C	D	E
Terminating Phase	A	-	6	7	9	
	B	6	-	6	7	9
	C	6	6	-	11	
	D	6	6	-	11	
	E	15	15	15	15	

Traffic Flows, Desired

Desired Flow :

		Destination				
		A	B	C	D	Tot.
Origin	A	0	28	39	36	103
	B	16	0	286	1892	2194
	C	10	91	0	2	103
	D	29	1649	2	0	1680
	Tot.	55	1768	327	1930	4080

Signal Timings Diagram

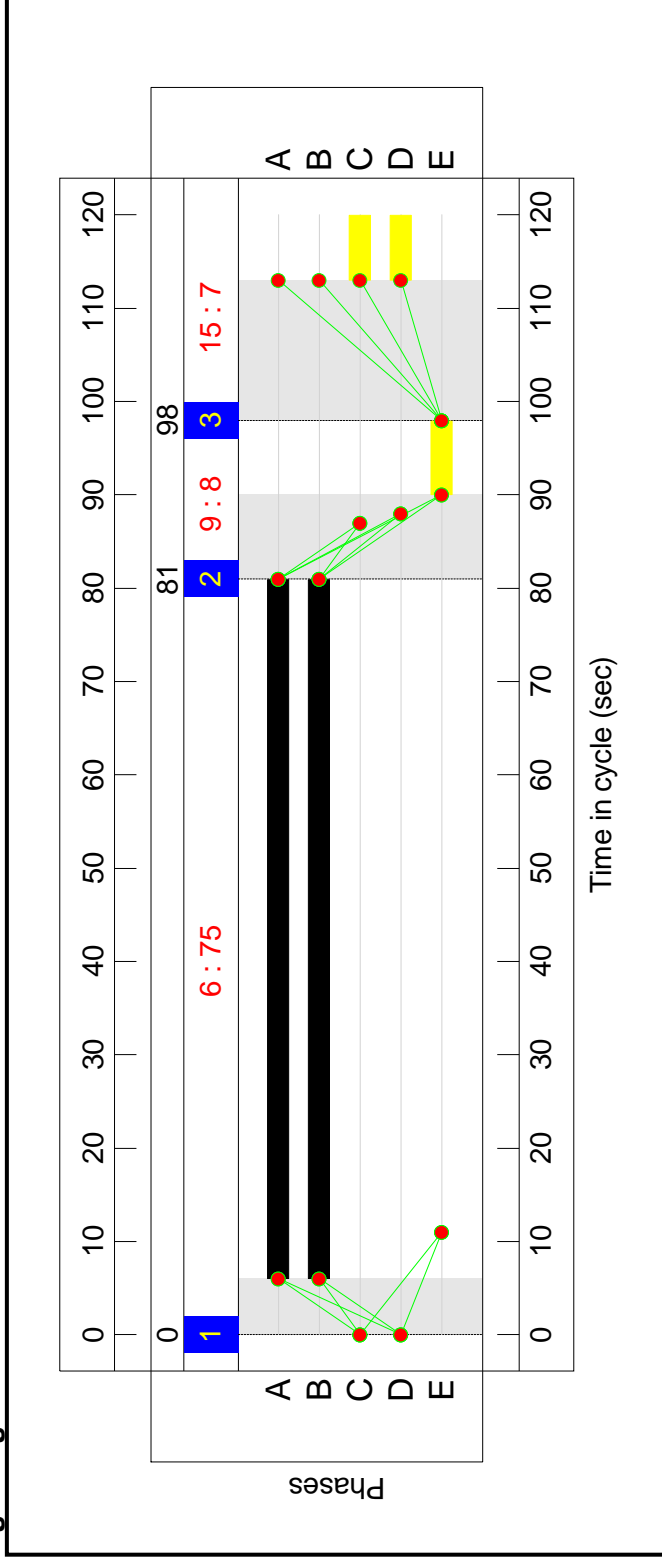

Network Results

Item	Lane Description	Full Phase	Demand Flow (pcu)	Deg Sat (%)	Av. Delay Per PCU (s/pcu)	Mean Max Queue (pcu)	
1/1	Glamis Road (N) Left Ahead Right	D	103	50.2%	67.2	3.7	
2/1	The Highway (E) Left Ahead	B	1097	103.6%	122.4	66.5	
2/2	The Highway (E) Right Ahead	B	1097	103.6%	122.9	66.5	
3/1	Glamis Road (S) Ahead Right Left	C	103	51.1%	70.0	3.7	
4/1	The Highway (W) Left Ahead	A	840	68.0%	18.2	18.8	
4/2	The Highway (W) Ahead Right	A	840	63.1%	16.7	17.7	
C1		PRC for Signalled Lanes (%): PRC Over All Lanes (%)	-15.1 -15.1	Total Delay for Signalled Lanes (pcuHr): Total Delay Over All Lanes (pcuHr):	86.83 86.83	Cycle Time (s):	120

C.4 Construction base case results, PM peak hour

Network Layout Diagram

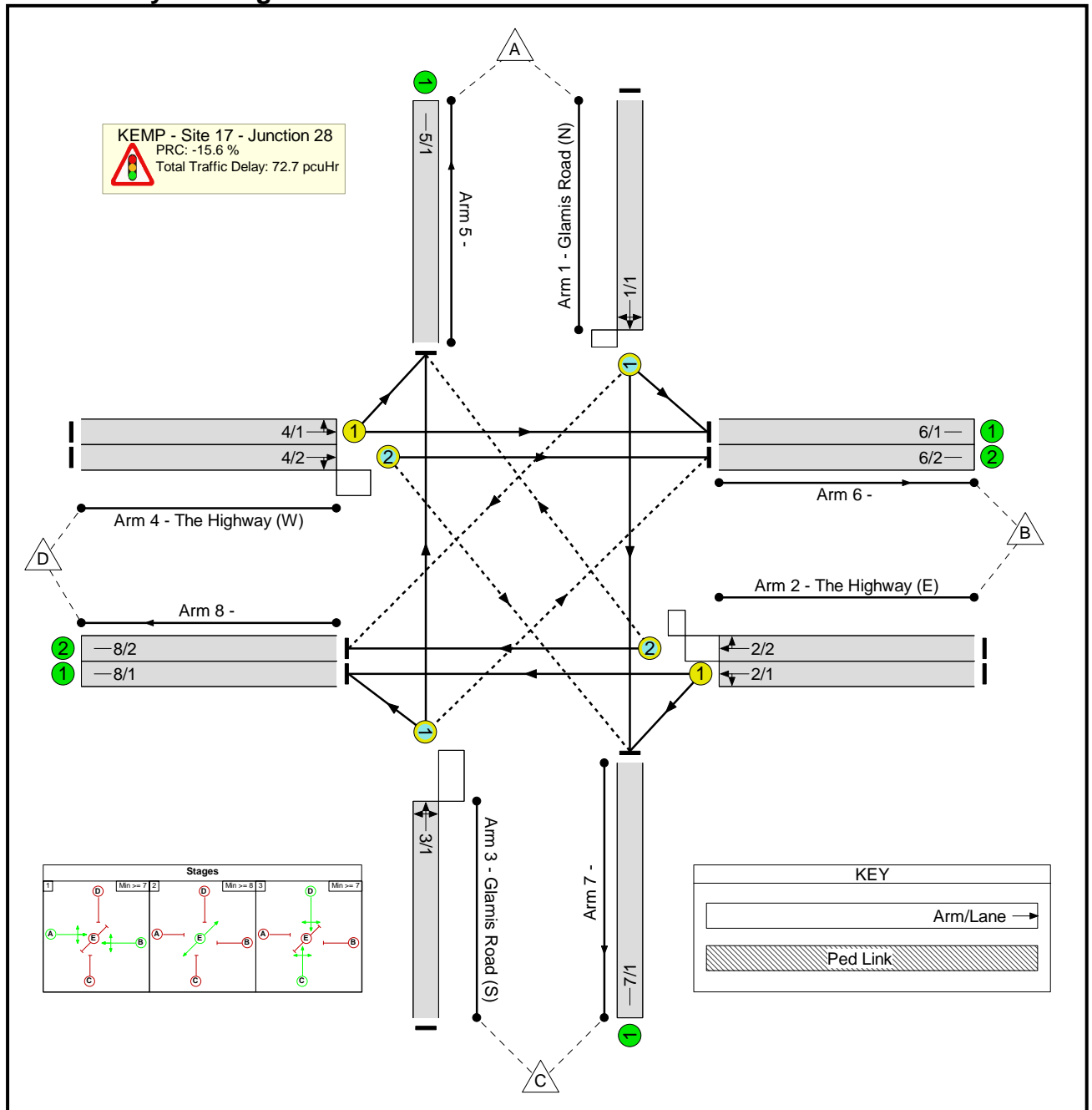

Phase Diagram

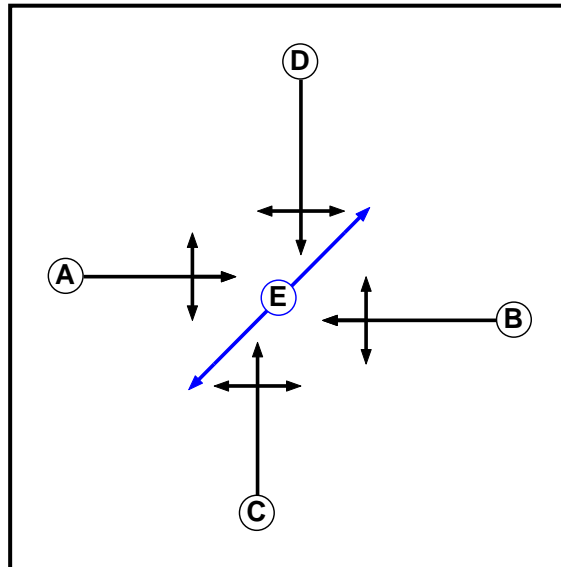

Stage Diagram

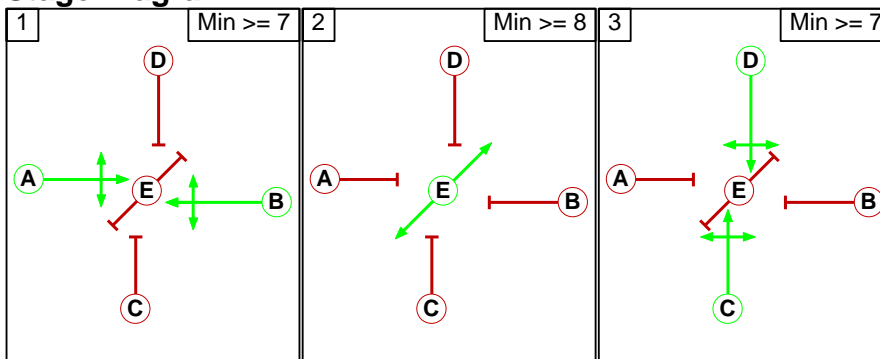

Phases in Stage

Stage No.	Phases in Stage
1	A B
2	E
3	C D

Phase Intergreens Matrix

		Starting Phase				
		A	B	C	D	E
Terminating Phase	A	-	6	7	9	
	B	6	-	6	7	9
	C	6	6	-	11	
	D	6	6	-	11	
	E	15	15	15	15	

Traffic Flows, Desired

Desired Flow :

		Destination				
		A	B	C	D	Tot.
Origin	A	0	48	30	24	102
	B	32	0	123	1766	1921
	C	13	207	0	4	224
	D	20	2069	2	0	2091
	Tot.	65	2324	155	1794	4338

Signal Timings Diagram

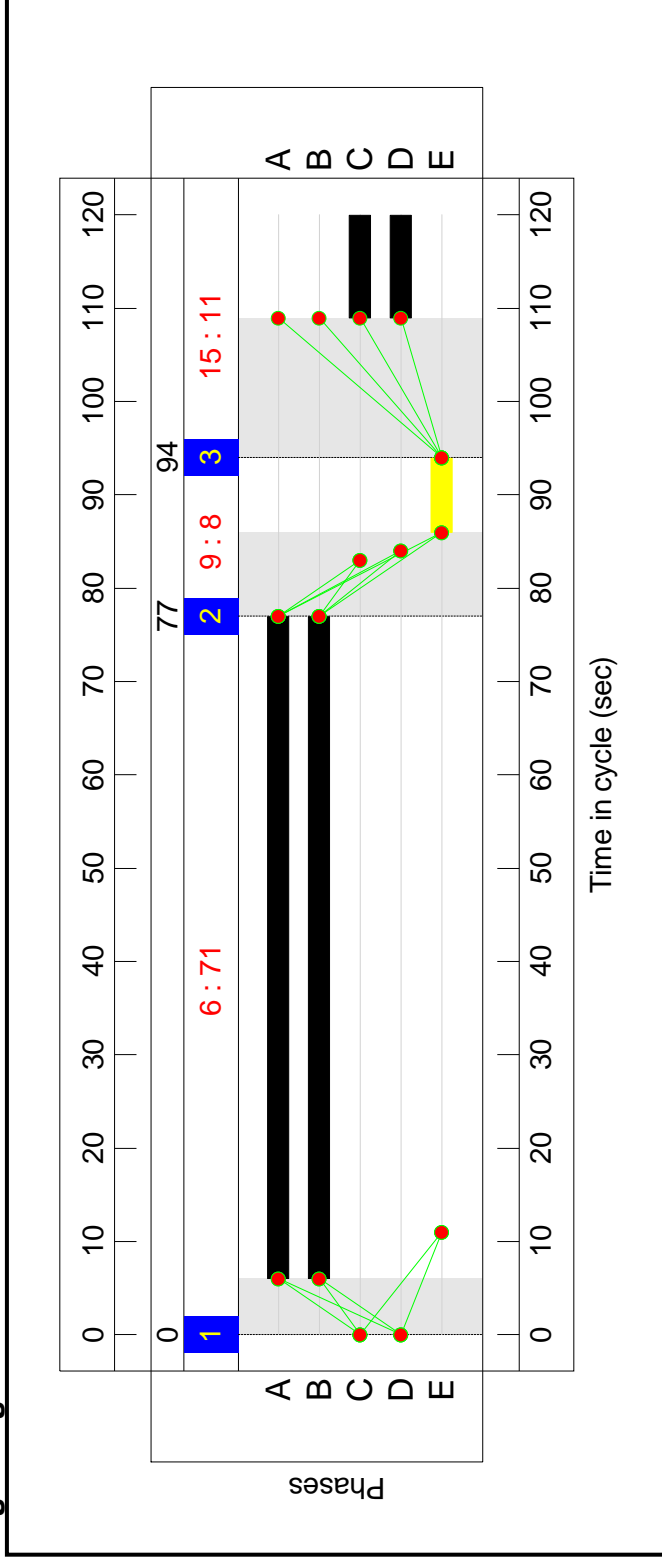

Network Results

Item	Lane Description	Full Phase	Demand Flow (pcu)	Deg Sat (%)	Av. Delay Per PCU (s/pcu)	Mean Max Queue (pcu)	
1/1	Glamis Road (N) Left Ahead Right	D	102	47.0%	64.4	3.6	
2/1	The Highway (E) Left Ahead	B	961	97.1%	59.9	40.3	
2/2	The Highway (E) Right Ahead	B	960	100.1%	83.4	46.2	
3/1	Glamis Road (S) Ahead Right Left	C	224	104.1%	224.9	17.8	
4/1	The Highway (W) Left Ahead	A	1046	90.4%	36.0	34.6	
4/2	The Highway (W) Ahead Right	A	1045	84.0%	28.2	30.4	
C1			PRC for Signalled Lanes (%): PRC Over All Lanes (%):	-15.6 -15.6	Total Delay for Signalled Lanes (pcuHr): Total Delay Over All Lanes (pcuHr):	72.69 72.69	Cycle Time (s): 120

C.5 Construction development case results, AM peak hour

Network Layout Diagram

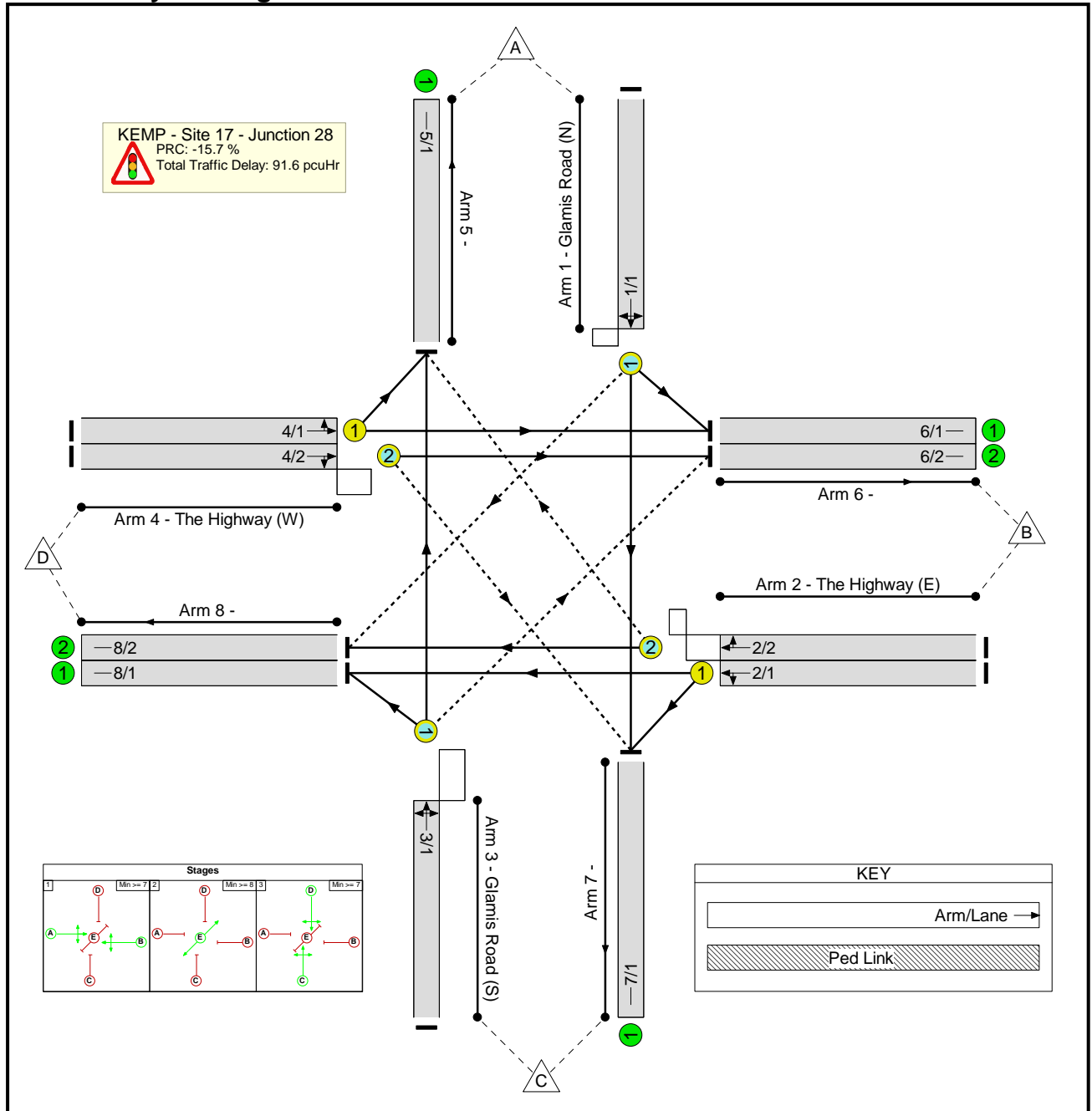

Phase Diagram

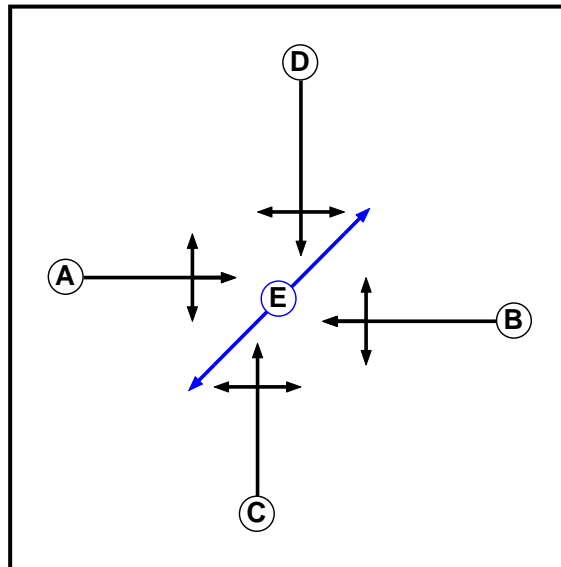

Stage Diagram

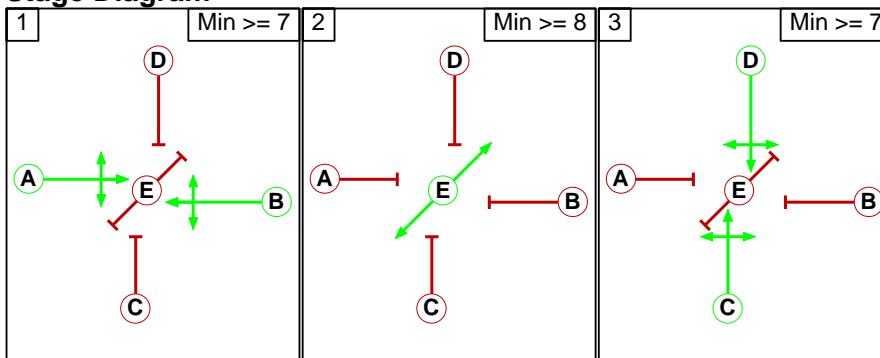

Phases in Stage

Stage No.	Phases in Stage
1	A B
2	E
3	C D

Phase Intergreens Matrix

		Starting Phase				
		A	B	C	D	E
Terminating Phase	A	-	6	7	9	
	B	6	-	6	7	9
	C	6	6	-	11	
	D	6	6	-	11	
	E	15	15	15	15	

Traffic Flows, Desired

Desired Flow :

		Destination				
		A	B	C	D	Tot.
Origin	A	0	28	39	36	103
	B	16	0	296	1892	2204
	C	10	101	0	2	113
	D	29	1649	2	0	1680
	Tot.	55	1778	337	1930	4100

Signal Timings Diagram

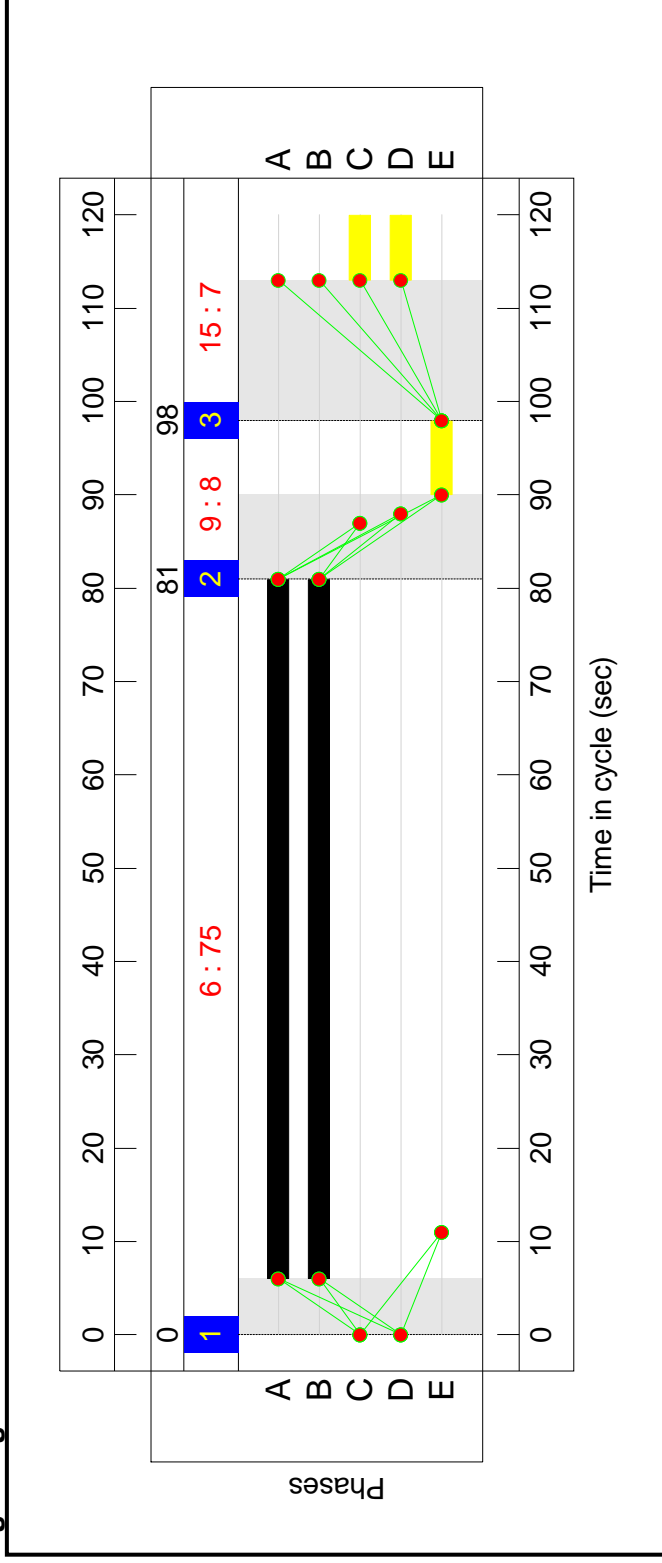

Network Results

Item	Lane Description	Full Phase	Demand Flow (pcu)	Deg Sat (%)	Avg. Delay Per PCU (s/pcu)	Mean Max Queue (pcu)	
1/1	Glamis Road (N) Left Ahead Right	D	103	50.2%	67.2	3.7	
2/1	The Highway (E) Left Ahead	B	1102	104.1%	129.1	68.8	
2/2	The Highway (E) Right Ahead	B	1102	104.1%	129.7	68.8	
3/1	Glamis Road (S) Ahead Right Left	C	113	56.1%	72.4	4.2	
4/1	The Highway (W) Left Ahead	A	840	68.0%	18.2	18.8	
4/2	The Highway (W) Ahead Right	A	840	63.1%	16.7	17.7	
C1		PRC for Signalled Lanes (%): PRC Over All Lanes (%)	-15.7 -15.7	Total Delay for Signalled Lanes (pcuHr): Total Delay Over All Lanes (pcuHr):	91.57 91.57	Cycle Time (s):	120

C.6 Construction development case results, PM peak hour

Network Layout Diagram

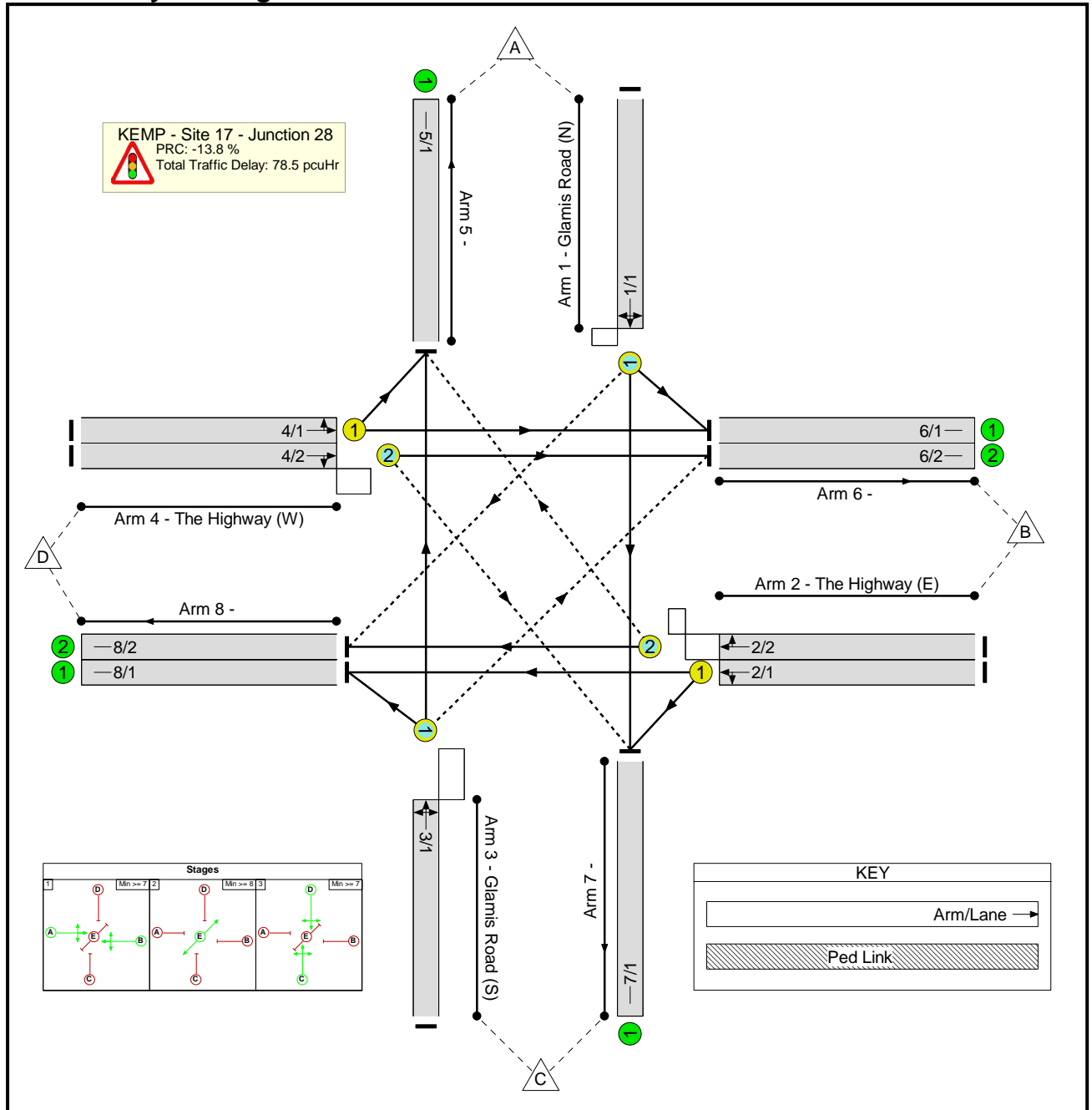

Phase Diagram

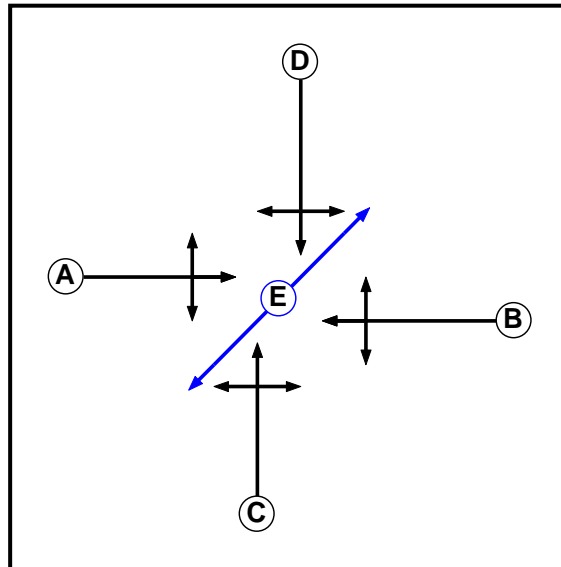

Stage Diagram

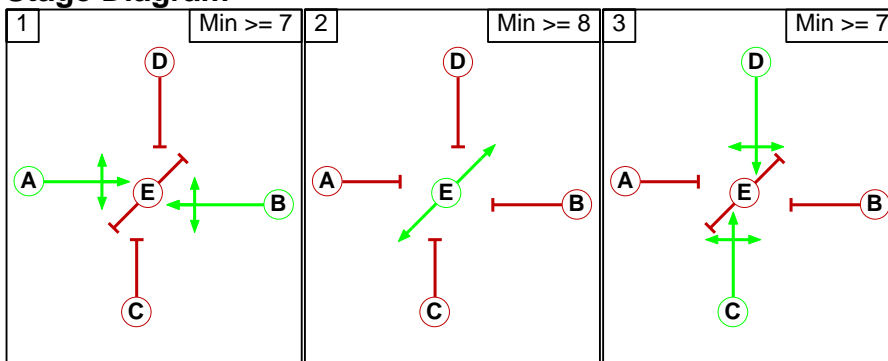

Phases in Stage

Stage No.	Phases in Stage
1	A B
2	E
3	C D

Phase Intergreens Matrix

		Starting Phase				
		A	B	C	D	E
Terminating Phase	A	-	6	7	9	
	B	6	-	6	7	9
	C	6	6	-	11	
	D	6	6	-	11	
	E	15	15	15	15	

Traffic Flows, Desired

Desired Flow :

		Destination				
		A	B	C	D	Tot.
Origin	A	0	48	30	24	102
	B	32	0	132	1766	1930
	C	13	218	0	4	235
	D	20	2069	3	0	2092
	Tot.	65	2335	165	1794	4359

Signal Timings Diagram

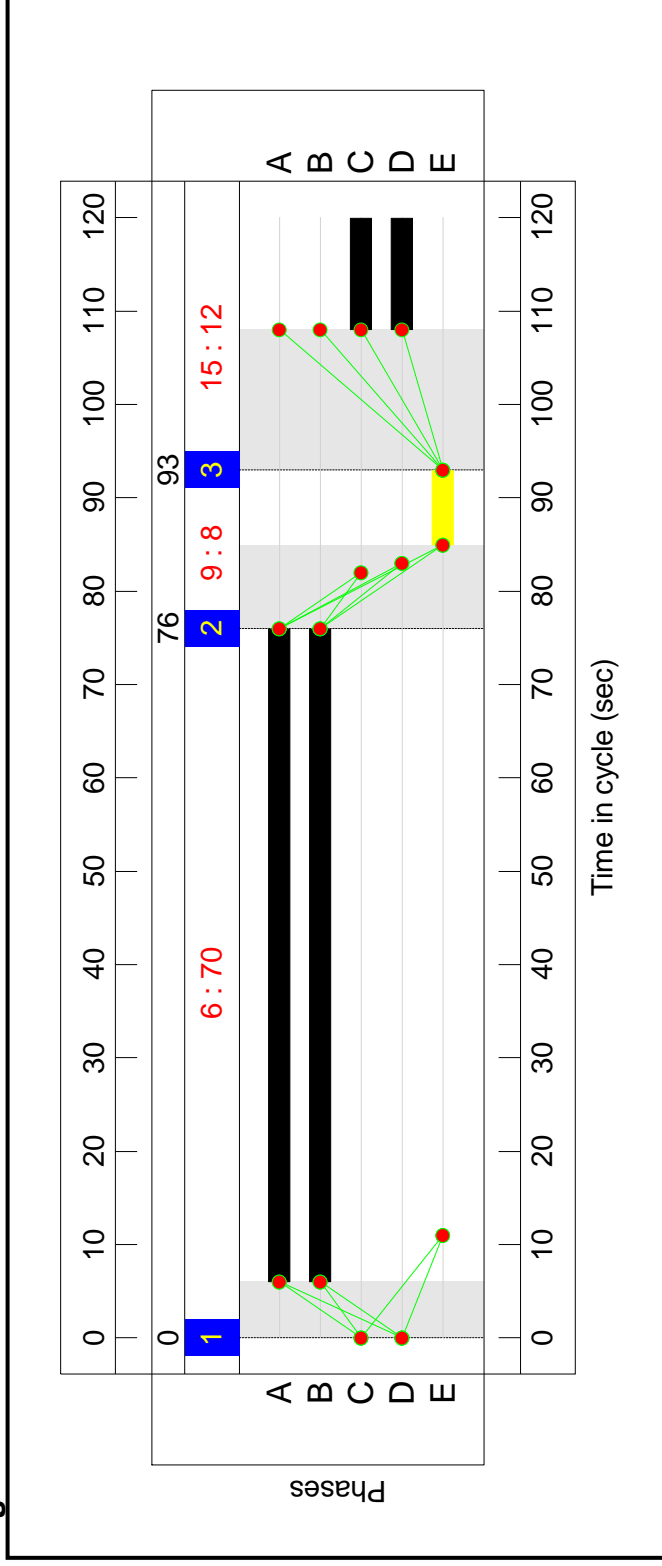

Network Results

Item	Lane Description	Full Phase	Demand Flow (pcu)	Deg Sat (%)	Av. Delay Per PCU (s/pcu)	Mean Max Queue (pcu)
1/1	Glamis Road (N) Left Ahead Right	D	102	44.0%	61.7	3.5
2/1	The Highway (E) Left Ahead	B	965	98.8%	72.5	44.6
2/2	The Highway (E) Right Ahead	B	965	100.7%	90.2	49.5
3/1	Glamis Road (S) Ahead Right Left	C	235	102.4%	200.8	17.2
4/1	The Highway (W) Left Ahead	A	1046	91.6%	39.0	36.1
4/2	The Highway (W) Ahead Right	A	1046	85.2%	29.9	31.3
		C1	PRC for Signalled Lanes (%): PRC Over All Lanes (%)	-13.8 -13.8	Total Delay for Signalled Lanes Total Delay Over All Lanes	

C.7 Construction development case results, 'all by road' sensitivity test, AM peak hour

Network Layout Diagram

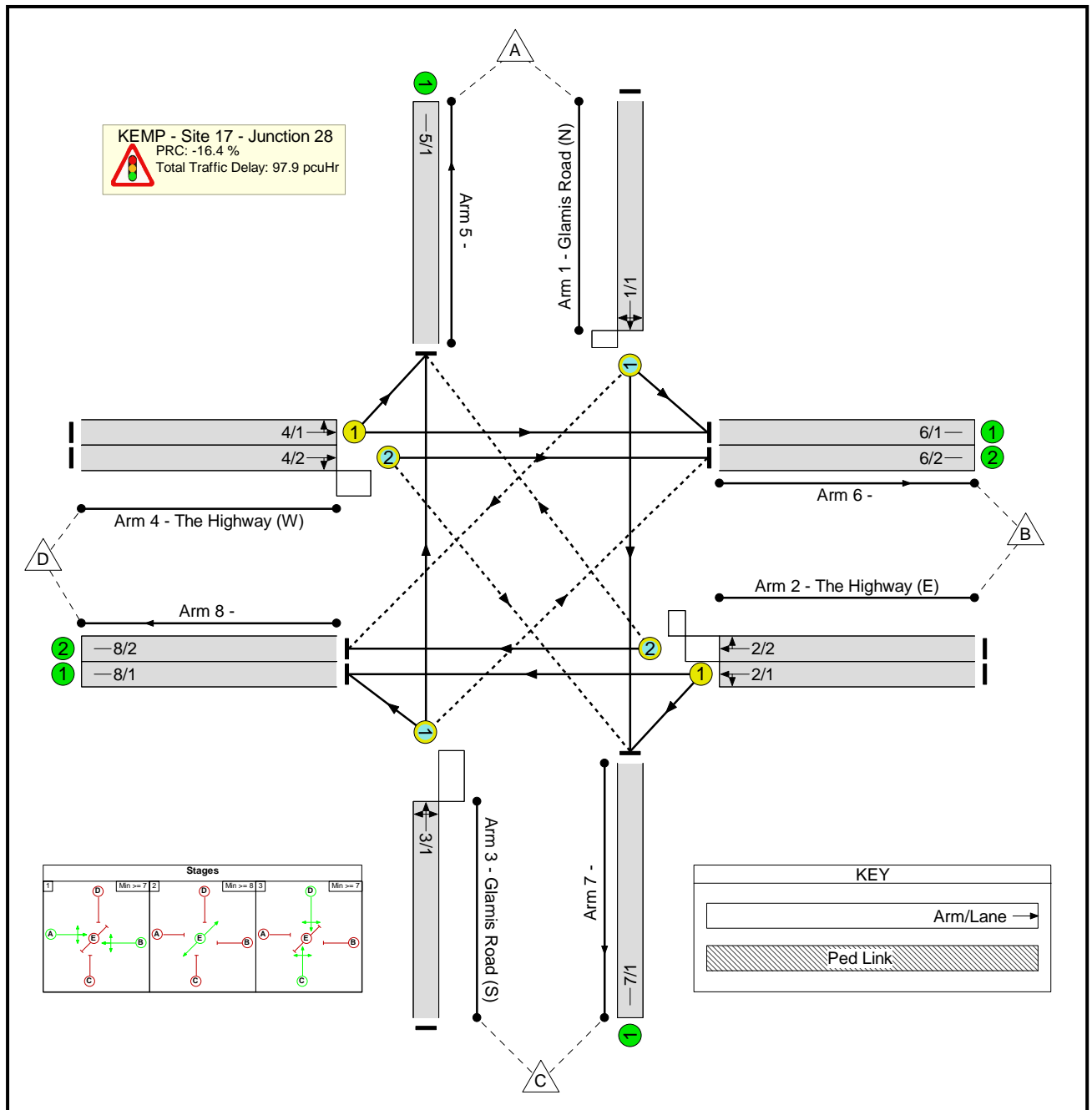

Phase Diagram

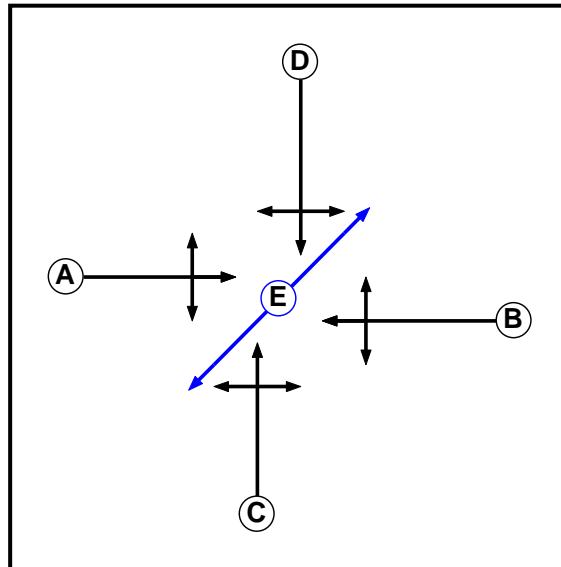

Stage Diagram

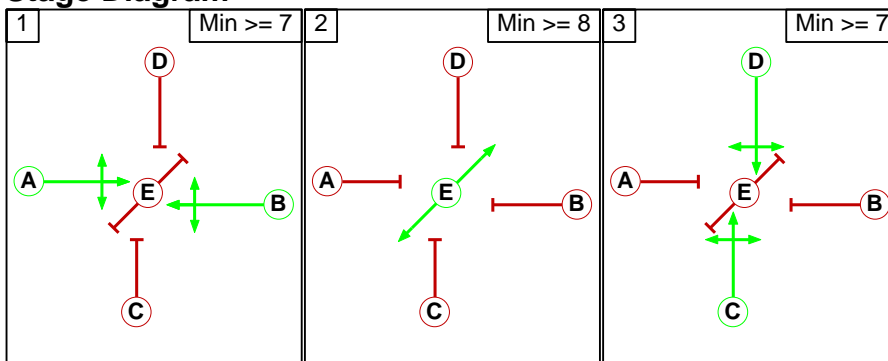

Phases in Stage

Stage No.	Phases in Stage
1	A B
2	E
3	C D

Phase Intergreens Matrix

		Starting Phase				
		A	B	C	D	E
Terminating Phase	A	-	6	7	9	
	B	6	-	6	7	9
	C	6	6	-	11	
	D	6	6	-	11	
	E	15	15	15	15	

Traffic Flows, Desired

Desired Flow :

		Destination				
		A	B	C	D	Tot.
Origin	A	0	28	39	36	103
	B	16	0	309	1892	2217
	C	10	114	0	2	126
	D	29	1649	2	0	1680
	Tot.	55	1791	350	1930	4126

Signal Timings Diagram

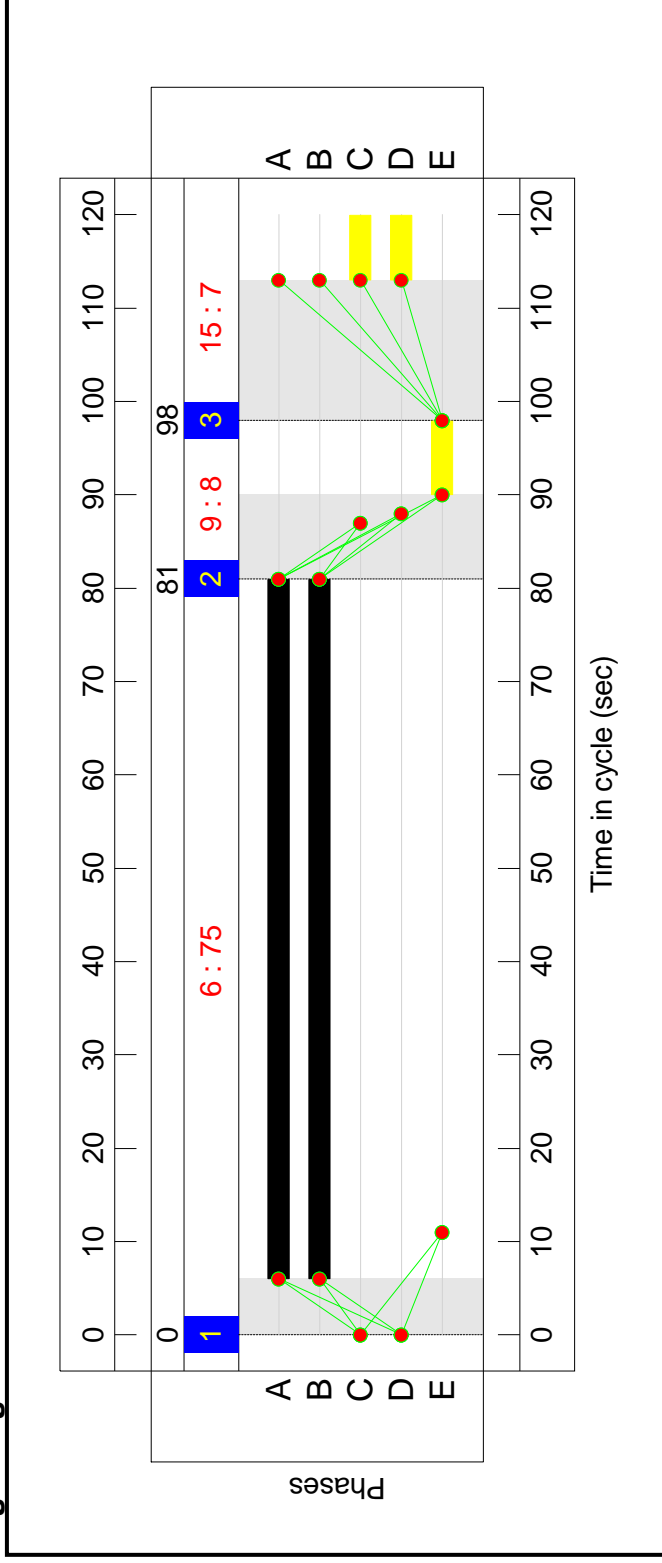

Network Results

Item	Lane Description	Full Phase	Demand Flow (pcu)	Deg Sat (%)	Av. Delay Per PCU (s/pcu)	Mean Max Queue (pcu)
1/1	Glamis Road (N) Left Ahead Right	D	103	50.2%	67.2	3.7
2/1	The Highway (E) Left Ahead	B	1109	104.7%	138.8	72.1
2/2	The Highway (E) Right Ahead	B	1108	104.7%	137.9	71.6
3/1	Glamis Road (S) Ahead Right Left	C	126	62.6%	76.4	4.8
4/1	The Highway (W) Left Ahead	A	840	68.0%	18.2	18.8
4/2	The Highway (W) Ahead Right	A	840	63.1%	16.7	17.7
		C1	PRC for Signalled Lanes (%): PRC Over All Lanes (%)	-16.4 -16.4	Total Delay for Signalled Lanes Total Delay Over All Lanes	

C.8 Construction base case results, 'all by road' sensitivity test, PM peak hour

Network Layout Diagram

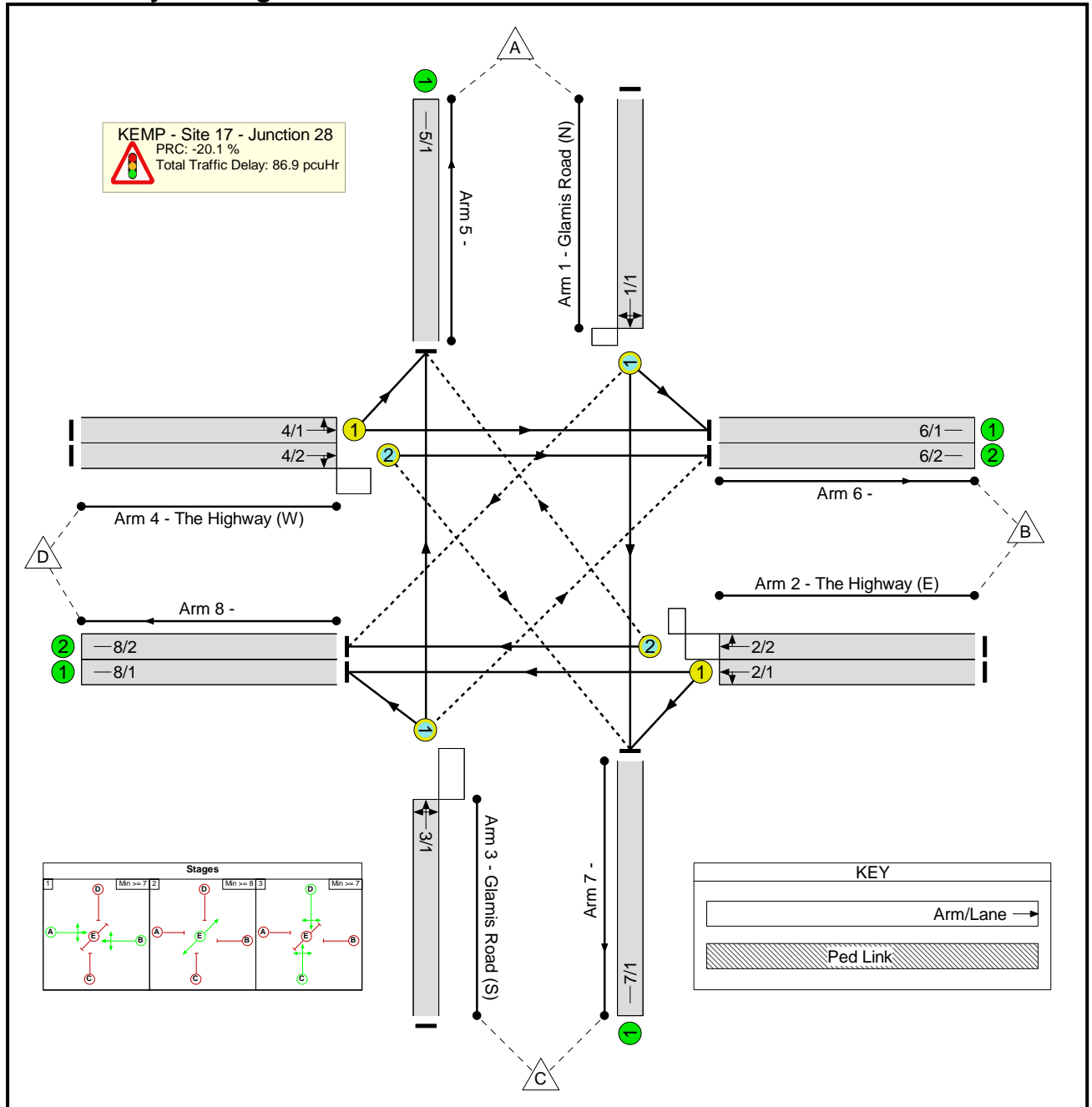

Phase Diagram

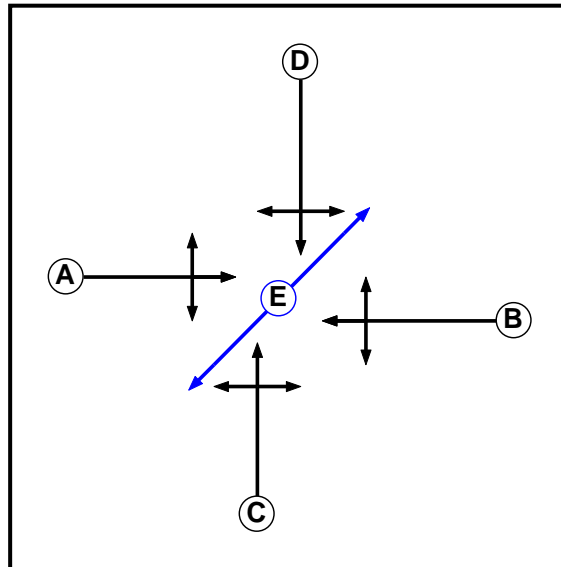

Stage Diagram

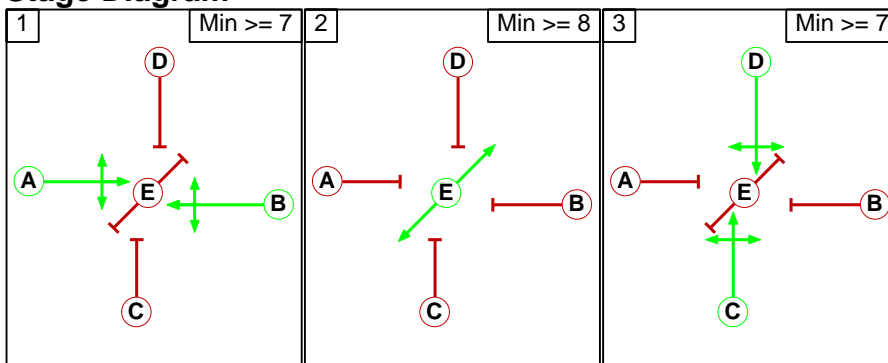

Phases in Stage

Stage No.	Phases in Stage
1	A B
2	E
3	C D

Phase Intergreens Matrix

		Starting Phase				
		A	B	C	D	E
Terminating Phase	A	-	6	7	9	
	B	6	-	6	7	9
	C	6	6	-	11	
	D	6	6	-	11	
	E	15	15	15	15	

Traffic Flows, Desired

Desired Flow :

		Destination				
		A	B	C	D	Tot.
Origin	A	0	48	30	24	102
	B	32	0	145	1766	1943
	C	13	231	0	4	248
	D	20	2069	3	0	2092
	Tot.	65	2348	178	1794	4385

Signal Timings Diagram

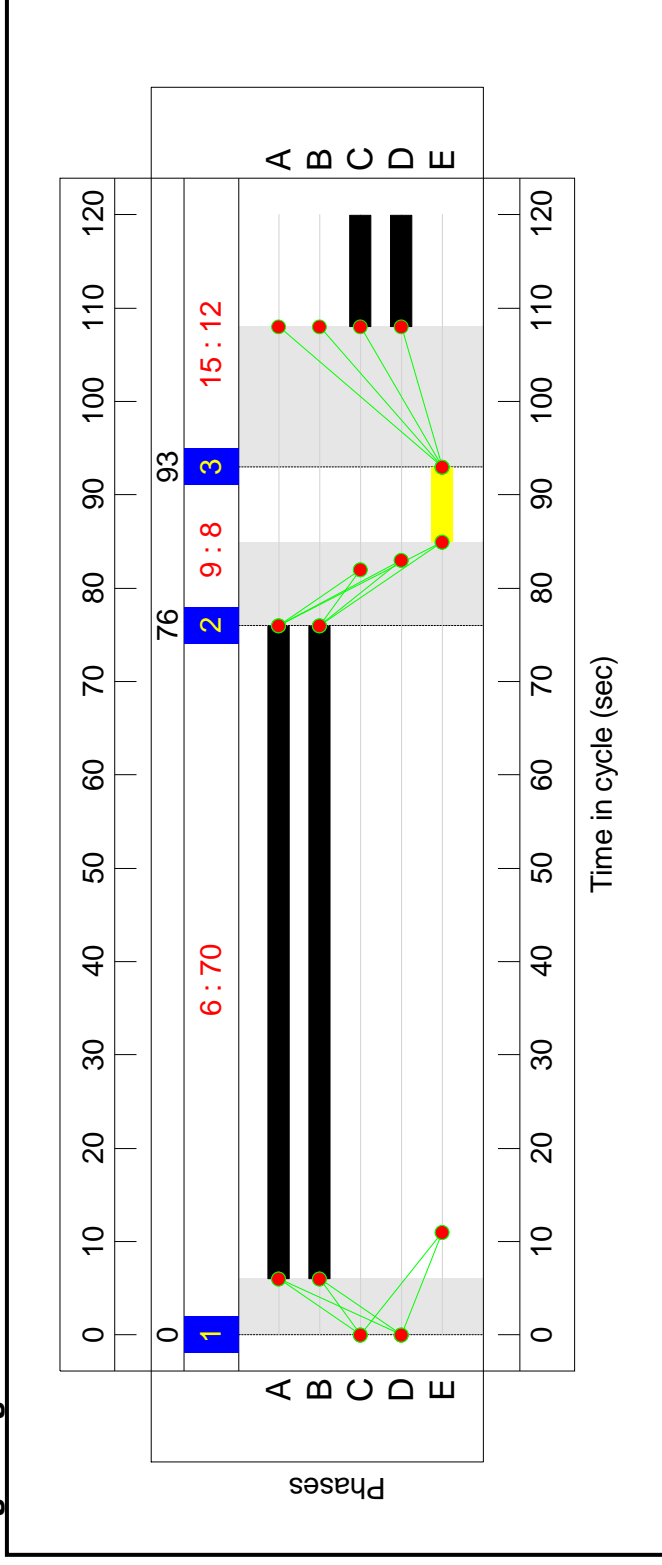

Network Results

Item	Lane Description	Full Phase	Demand Flow (pcu)	Deg Sat (%)	Av. Delay Per PCU (s/pcu)	Mean Max Queue (pcu)	
1/1	Glamis Road (N) Left Ahead Right	D	102	44.0%	61.7	3.5	
2/1	The Highway (E) Left Ahead	B	972	99.6%	78.3	46.7	
2/2	The Highway (E) Right Ahead	B	971	101.0%	93.6	50.6	
3/1	Glamis Road (S) Ahead Right Left	C	248	108.1%	272.7	23.1	
4/1	The Highway (W) Left Ahead	A	1046	91.6%	39.0	36.1	
4/2	The Highway (W) Ahead Right	A	1046	85.2%	29.9	31.3	
C1			PRC for Signalised Lanes (%): PRC Over All Lanes (%):	-20.1 -20.1	Total Delay for Signalised Lanes (pcuHr): Total Delay Over All Lanes (pcuHr):	86.93 86.93	Cycle Time (s): 120

This page is intentionally blank

Appendix D: Accident analysis

D.1 Existing highway safety analysis

- D.1.1 Details of road traffic accident within the vicinity of the site have been obtained from Transport for London (TfL) and have been reviewed to determine whether there are particular problems or trends on the local highway network.
- D.1.2 Data on accidents for 5 years until the end of March 2011 has been analysed for the following junctions and surrounding roads:
- A1203 The Highway;
 - The Highway/ Glamis Road Junction; and
 - The Highway/ King David Lane Junction.
- D.1.3 Based on the DfT Design Manual for Roads and Bridges, Volume 13 Economic Assessment of Road Schemes, accidents have been analysed according to the method outlined in this guidance which states that accidents that have occurred within 20m of each junction are associated with that specific junction, and the remaining accidents are grouped to the relevant links.
- D.1.4 The area of interest together with the locations of the recorded road traffic accidents and the severity of the accidents are indicated in Table D.1.

Accident severity 2006 to 2011

Location	Slight	Serious	Fatal	Total
A1203 The Highway	6	1	0	7
The Highway/ Glamis Road Junction	14	4	1	19
The Highway/ King David Lane Junction	13	2	0	15
The Highway/ Dellow Street Junction	3	3	0	6
The Highway/ Brodlove Lane Junction	4	1	0	5
The Highway/ Schoolhouse Lane Junction	3	1	0	4
The Highway/ Garnet Street Junction	6	1	0	7
The Highway/ Garnet Road Junction	0	1	0	1
Brodlove Lane/ Glamis Place Junction	0	1	0	1
Total	49	15	1	65

- D.1.1 A total of 65 road traffic accidents have occurred in the area of interest during the five year period. These have been assessed in this section.
- D.1.2 Of these accidents, 49 are classified as slight, 15 is classified as serious and 1 as fatal. Table 1.1 below summarises where these accidents

occurred, and their level of severity. Accident analysis for the individual junctions and roads sections is discussed below.

A1203 The Highway

D.1.3 The A1203 The Highway section runs parallel to the north of the site boundary and extends as far as the A13 at Limehouse in the east and the A100 at Tower Hill in the west. For the stretch of the A1203 within the study area, the highway is a double lane dual carriageway operating in a west-east direction. The junctions involved within this analysis are as follows:

- The Highway/ Glamis Road Junction;
- The Highway/ King David Lane Junction;
- The Highway/ Glasshouse Fields Junction;
- The Highway/ Dellow Street Junction;
- The Highway/ Brodlove Lane Junction;
- The Highway/ Schoolhouse Lane Junction;
- The Highway/ Garnet Street Junction; and
- The Highway/ Garnet Road Junction.

D.1.4 In total 64 accidents have occurred along the A1203 The Highway and the junction associated with this stretch of highway. In relation to the severity of these accidents, 49 were slight accidents, predominantly resulting from failure to look properly, poor manoeuvring and travelling too fast for the conditions.

D.1.5 Of the total accidents, 14 were classified as serious. The accidents involved a car and/ or another vehicle/ pedestrian/ cyclist/ motorcyclist. The major contributory factor to the serious accidents was failure to look properly, failure to judge other person's path or speed and careless/reckless driving.

D.1.6 The 1 fatal accident that occurred along the A1203 The Highway in the 5 year period analysed, occurred with the Glamis Road junction to the west of the site. The accident involved a motorcyclist travelling on the wrong side of an island and hitting a turning 3.5te light goods vehicle (LGV). The accident was caused by the motorcyclist travelling in an illegal direction of travel and careless/ reckless driving.

Brodlove Lane/ Glamis Place

D.1.7 Brodlove Lane/ Glamis Place junction runs to the north of the site and had 1 slight accident occur on it during the 5 year period analysed. The accident involved two cars and the cause of the accident was failure to look properly, vision affected and failure to obey gives way or stop sign.

D.1.8 There was no fatal or serious accidents on these roads during the 5 year period analysed.

D.2 Summary and conclusion

- D.2.1 The largest number of road traffic accidents had occurred at The Highway junction with Glamis Road; which have been classified as 14 slight, 4 serious and 1 fatal.
- D.2.2 The 1 fatal accident that occurred within this study area is attributed to the motorcyclist travelling on the illegal side of an island and hitting the turning 3.5te LGV. Careless/ reckless driving was also considered a contributory factor to the accident and it was considered not to be due to road geometry or failure of infrastructure.
- D.2.3 In total 15 serious accidents occurred within the study area, 4 on Glamis Road and 3 on Dellow Street and the rest were sprinkled across the other junctions. For the accidents on Glamis Road the vehicles involved are a combination of car/car and car/motorcyclist. The contributory factor to each of the accidents was a failure to look properly, poor turning/ manoeuvring and careless/ reckless driving.
- D.2.4 Overall, the accidents occurred in the area of interest were mainly caused as a result of the poor turning movements and a failure to look properly which resulted in careless/ reckless driving which indicates that the accidents are not due to highway geometry.

This page is intentionally blank

Appendix E: Road Safety Audit

This page is intentionally blank

Thames Tideway Tunnel
The Point (7th Floor),
37 North Wharf Road,
Paddington,
London W2 1AF
For the attention of Dermot Scanlon

Central Square
Forth Street
Newcastle upon Tyne
NE1 3PL
United Kingdom
t +44 191 261 6080
f +44 191 261 7879
chris.van-lottum@arup.com-
www.arup.com

15 February 2013

Dear Sirs

Thames Tideway Tunnel King Edward Memorial Park Foreshore – Stage 1 Road Safety Audit

I have the pleasure of enclosing our King Edward Memorial Park Foreshore – Stage 1 Road Safety Audit report. In addition to the enclosed report, the Audit Team noted the following point outwith the remit of the audit. I would be grateful if you would bring this issue to the attention of the Highway Authority, Designer and/or Maintainer as appropriate.

Additional Comment

- The Thames Path through King Edward Memorial Park forms part of National Cycle Network Route 13 and the Thames Cycle Route. Any traffic management proposed on this road should take full account of cycles. Furthermore delivery drivers should be made aware of the presence of the cycle routes and the likely increased risk of cycle / goods vehicle conflict.



If you have any further queries regarding this letter or the enclosed report, please do not hesitate to contact me

Yours faithfully

A handwritten signature in black ink, consisting of a large, stylized initial 'C' followed by a horizontal line extending to the right.

Chris van Lottum
Senior Engineer
Road Safety Audit Team Leader

Enc

cc Phil Longman, Peter Brett Associates
Gavin Wicks, Arup

Thames Tideway Tunnel

Thames Tideway Tunnel – King Edward Memorial Park Foreshore

Stage 1 Road Safety Audit

RSA1.1a

Rev A | 15 February 2013

This report takes into account the particular instructions and requirements of our client.

It is not intended for and should not be relied upon by any third party and no responsibility is undertaken to any third party.





Job number 211146-03

Ove Arup & Partners Ltd
Central Square
Forth Street
Newcastle-upon-Tyne NE1 3PL
United Kingdom
www.arup.com

ARUP

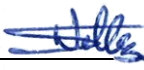
Document Verification

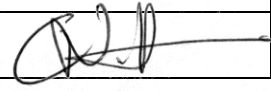
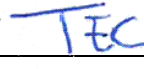
ARUP

Job title		Thames Tideway Tunnel – King Edward Memorial Park Foreshore		Job number		211146-03	
Document title		Stage 1 Road Safety Audit		File reference			
Document ref		RSA1.1a					
Revision	Date	Filename	RP CVL TTT 21 King Edward RSA1.1 130115 Rev A.docx				
Issue	11 Jan 2013	Description	Issue Document				
			Prepared by	Checked by	Approved by		
		Name	Chris van Lottum	Steve Wells	Steve Wells		
		Signature					
Rev A	15 Feb 2013	Filename	RP CVL TTT 21 King Edward RSA1.1 130115 Rev A.docx				
		Description	Devised documents recieved				
			Prepared by	Checked by	Approved by		
		Name	Chris van Lottum	Tom Corke	Steve Wells		
Signature							
		Filename					
		Description					
			Prepared by	Checked by	Approved by		
		Name					
Signature							
		Filename					
		Description					
			Prepared by	Checked by	Approved by		
		Name					
Signature							

Issue Document Verification with Document



Contents

	Page
1 Introduction	1
1.1 Site Description	2
1.2 Scheme Description	2
2 Stage 1 Road Safety Audit	3
2.1 Construction Layout	3
2.2 Permanent Layout	7
3 Road Safety Audit Statement	8

Figures

Figure 1 Location of Recommendations

Appendices

Appendix A

Documents and Drawings

1 Introduction

Arup was appointed by Thames Tideway Tunnel to conduct a Stage 1 Road Safety Audit on proposals to create a construction access and egress for works associated with the Thames Tideway Tunnel at King Edward Memorial Park Foreshore, Glamis Road in the London Borough of Tower Hamlets.

The agreed Audit Team consisted of:

- Mr C van Lottum MEng (Hons), MCIHT, MSoRSA
- Mr T Corke BEng (Hons), MSc, CEng, MICE, MCIHT, MSoRSA

The Audit Team visited the site together on Wednesday 12th December 2012; weather conditions at the time of the site visit were bright but very cold and the road surface was dry.

A list of information provided to the Audit Team has been included as Appendix A to this Report.

The following information was **not** made available to the Audit Team and as such any specific influence of these details on road user safety has not been considered by this audit:

- Departures from Standard
- Road profiles
- Cross sections
- Drainage
- Landscape
- Public utilities
- Traffic signals
- Traffic signs
- Street lighting
- Road markings
- Road restraint systems

It is understood that no previous road safety audits have been conducted on this scheme.

This audit has been undertaken in accordance with the Terms of Reference set out in TfL Procedure ‘Road Safety Audit SQA-0170 – Issue 4’; and the Audit Team members meet the training and experience requirements set out therein. The Audit Team has examined and reported only on the road safety implications of the scheme as presented and has not examined or verified the compliance of the design to any other criteria. However, to clearly explain a problem or recommendation the Audit Team may occasionally refer to design standards without engaging in technical audit.

All problems and recommendations identified by this audit are referenced to the design drawings and the locations have been indicated on the attached plan.

Other issues, including safety issues identified during the Audit, but excluded from this report by the Terms of Reference, which the Audit Team wishes to draw to the attention of the Audit Project Sponsor, are set out in separate correspondence.

Road Safety Audit is based upon a qualitative risk assessment process and there is no measure of the success achieved by any recommendations given herein. Road Safety Audit cannot guarantee the safe operation of the scheme under consideration in this report as accidents are rare and random events and are largely caused by factors outside the Audit Team's influence, such as driving behaviour and, to a lesser extent, vehicle condition.

1.1 Site Description

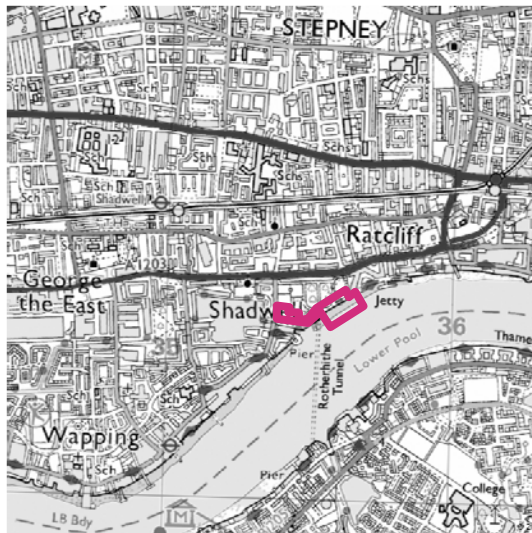

Scheme Location

The King Edward Memorial Park Foreshore site is located on the north bank of the River Thames to the east of the Rotherhithe Tunnel. The park is accessed from Glamis Road to its west, and bounded by the A1203 The Highway on its north side.

1.2 Scheme Description

Vehicle access to and from the site would take place via a new permanent gated access and vehicle route between Glamis Road and the site through the southern end of the playing field, tennis court and the Park.

To accommodate the movement of larger construction vehicles, into and out of the site, it would be necessary to suspend 15m of car parking on Glamis Road which would not be re-provided in the surrounding area.

The Thames Path would require diversion as a result of the construction works. However, a controlled crossing is to be provided to allow users to keep on the established route when it is not being used by construction vehicles.

When in use by construction vehicles, the Thames Path would be diverted through the western part of the King Edward Memorial Park to Glamis Road. From here, the diversion would lead south along the eastern footway of Glamis Road to rejoin the existing Thames Path route at the site access.

2 Stage 1 Road Safety Audit

The Recommendations below are numbered as follows:

STAGE . AUDIT NUMBER . RECOMMENDATION NUMBER

2.1 Construction Layout

Location: Junction of Glamis Road with The Highway

Summary: Existing accident record for delivery route could be exacerbated by construction traffic.

Description: There is an existing accident risk relating to vehicles turning on and off The Highway at Glamis Road and colliding with vulnerable road users.

The construction necessitates large numbers of HGV turning movements at this location which may exacerbate the existing problems.

S1.1.1 Recommendation: Traffic management layouts during construction should highlight the likelihood of HGV and plant movements at this location. Delivery drivers and site staff should be made aware of the likely increased risk of turning conflicts, particularly with vulnerable road users through inclusion in the site induction process and construction method statements.

Location: Glamis Road

Summary: The poor condition of existing traffic calming measures could lead to vehicle damage.

Description: Traffic calming has been installed in the form of speed cushions on Glamis Road. Some of the measures are in poor condition with missing ramps and loose / sunken blocks.



IMG_8752.jpg

Repeated over running by construction traffic is likely to exacerbate the existing problem, to a point at which vehicles could be damaged by debris.

S1.1.2 Recommendation: Remove the traffic calming measures for the duration of the works, and reinstate at the end of the construction phase.

Location: Glamis Road

Summary: The poor condition of existing carriageway could lead to vehicle damage.

Description: There is an area of poor carriageway condition on Glamis Road to the north of the site access.



IMG_8750.jpg

Repeated over running by construction traffic is likely to exacerbate the existing problem, to a point at which vehicles could be damaged by debris.

S1.1.3 Recommendation: Ensure the carriageway is maintained so as to remain safe for all users for the duration of the works

Location: Glamis Road

Summary: Tight swept path could result in vehicle damage.

Description: The swept path analysis for the construction layout indicates conflicts between some vehicle types approaching / leaving the site, while avoiding the parking bays on Glamis Road immediately north of the site access.

Swept path conflicts can lead to vehicle damage and could result in injuries for vehicle occupants or pedestrians if footways are over run to avoid a collision.

S1.1.4 Recommendation: Suspend additional parking bays on Glamis Road so as to ensure unobstructed egress.

Location: Glamis Road

Summary: Gulley at the temporary site access likely to be damaged by repeated over running leading to loss of control collisions.

Description: It is proposed to open a site access on the eastern side of Glamis Road during the construction phase. There is a drainage gulley located in the channel at the kerb concurrent with the access.



IMG_8724.jpg

Repeated over-running of the gully could result in damage which in turn could damage a tyre or wheel resulting in rapid deflation and loss of control.

S1.1.5 Recommendation: Relocate the gully away from the access.

Location: King Edward Memorial Park

Summary: Narrow diversionary path could result in pedestrian / cycle conflicts

Description: The diversionary route for the Thames Path through the King Edward Memorial Park indicates a series of tight turns. There is no indication of the width of path to be provided.

The Thames Path through King Edward Memorial Park forms part of National Cycle Network Route 13 and the Thames Cycle Route. The path hosts joggers and pedestrians. Insufficient shared path width could result in pedestrian and cycle conflicts leading to injuries.

S1.1.6 Recommendation: Ensure the temporary path is sufficiently wide to accommodate both pedestrians and cycles, and that changes in direction have clear visibility and appropriate radii.

2.2 Permanent Layout

Location:	Glamis Road
Summary:	Tight swept path could result in vehicle damage
Description:	<p>The swept path analysis for the construction layout indicates conflicts between some vehicle types approaching / leaving the site, while avoiding the parking bays on Glamis Road immediately north of the site access.</p> <p>Swept path conflicts can lead to vehicle damage and could result in injuries for vehicle occupants or pedestrians if footways are over run to avoid a collision.</p>
S1.1.7 Recommendation:	Temporary suspension of parking bays on Glamis Road may be required during maintenance periods so as to ensure unobstructed access.

End of list of problems identified and recommendations offered in this Stage 1 Road Safety Audit.

3 Road Safety Audit Statement

I certify that this audit has been carried out in accordance with HD19/03.

Audit Team Leader

Mr C van Lottum MEng (Hons), MCIHT, MSoRSA

Senior Engineer

Arup

Central Square, Forth Street,
Newcastle upon Tyne, NE1 3PL

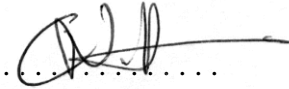

15 February 2013

Audit Team Member

Mr T Corke BEng (Hons), MSc, CEng, MICE, MCIHT,
MSoRSA

Senior Engineer

Arup

The Arup Campus, Blythe Gate, Blythe Valley Park,
Solihull, B90 8AE

Figures

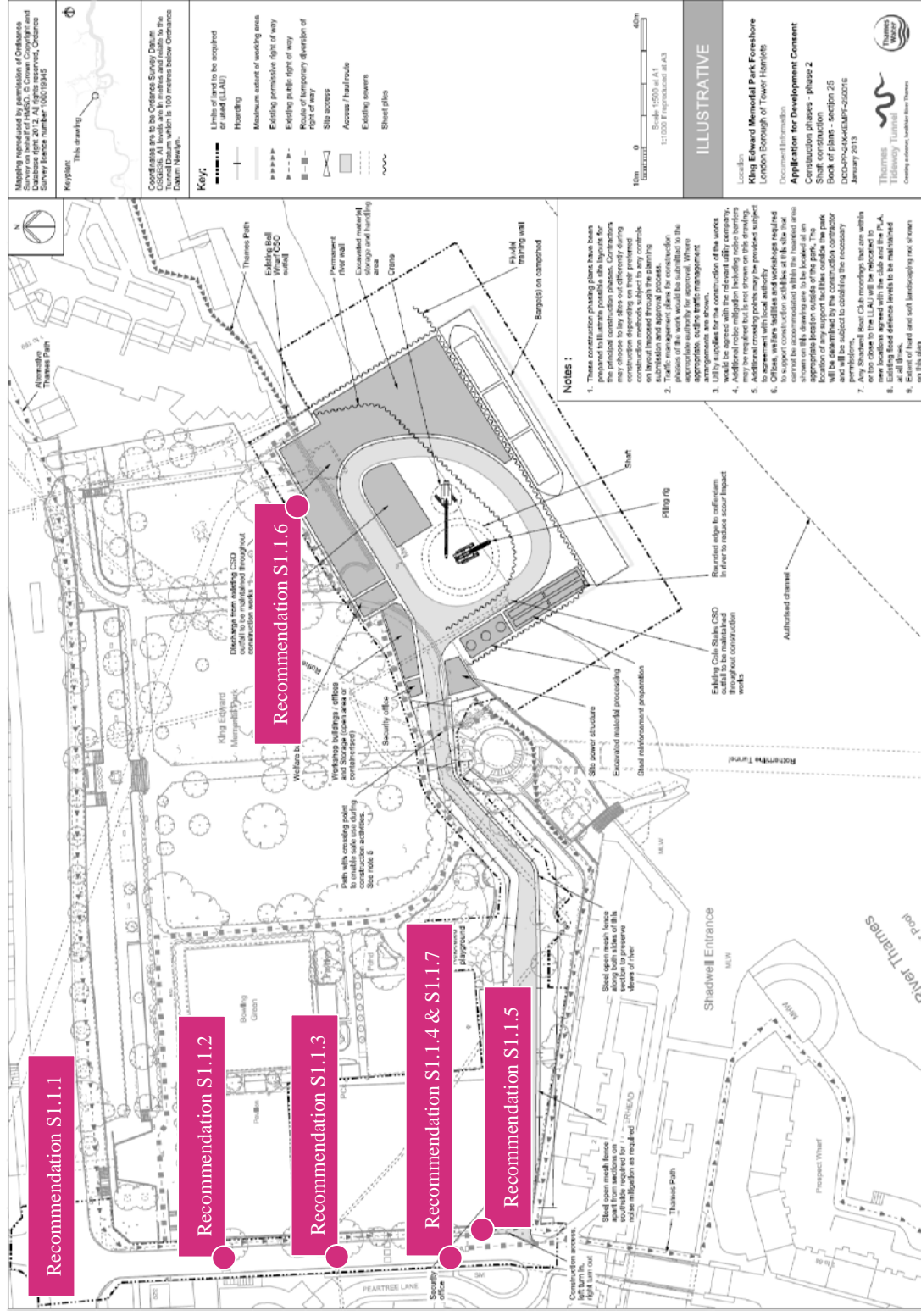

Figure 1 Location of Recommendations

Appendix A

Documents and Drawings

A1 Documents and Drawings

The following documents and drawings were supplied to the Audit Team by the Designer and have been examined in the course of conducting this audit.

A1.1 Documents

Title	Reference	Revision
Road Safety Audit Brief	-	16/12/2012
Road Accident Data	-	-

A1.2 Drawings

Title	Reference	Revision
Transport - site location plan	1PL03-TT-50614	Jan 2013
Transport - construction traffic routes	1PL03-TT-506061	Jan 2013
Transport - accident locations	1PL03-TT-50750	Jan 2013
Construction phases - phase 2 - Shaft construction	DCO-PP-24X-KEMPF-250016	Jan 2013
Highway layout during construction (Area 1)	DCO-PP-24X-KEMPF-250025	Jan 2013
Highway layout during construction (Area 2)	DCO-PP-24X-KEMPF-250026	Jan 2013
Permanent highway layout – Area 1 work	DCO-PP-24X-KEMPF-250027	Jan 2013
Highway layout during construction (Area 1) – Vehicle swept path analysis	DCO-PP-24X-KEMPF-250028	Jan 2013
Highway layout during construction (Area 2) – Vehicle swept path analysis	DCO-PP-24X-KEMPF-250029	Jan 2013
Permanent highway layout (Area 1) – Vehicle swept path analysis	DCO-PP-24X-KEMPF-250030	Jan 2013

This page is intentionally blank

PJob Name	Thames Tideway Tunnel – King Edward Memorial Park	
Job No.	22104	
Note No.	001	
Date	15 th February 2013	
Subject	Stage 1 Road Safety Audit – Designer’s Response	
Prepared by	L Harney	Reviewed: B Kemp

Peter Brett Associates LLP
16 Brewhouse Yard, Clerkenwell,
London, EC1V 4LJ
T: +44 (0)20 7025 7100
E: london@peterbrett.com

1 Introduction

- 1.1 Arup was appointed by Thames Water to conduct a Stage 1 Road Safety Audit on proposals to create a construction access and egress for works associated with the Thames Tideway Tunnel at King Edward Memorial Park (KEMP) in the London Borough of Tower Hamlets.
- 1.2 This technical note provides the Designer’s Response to the Stage 1 Audit for this site.

2 Stage 1 Road Safety Audit

Construction Layout

- 2.1 Location: Junction of Glamis Road with The Highway

Summary: Existing accident record for delivery route could be exacerbated by construction traffic.

Description: There is an existing accident risk relating to vehicles turning on and off The Highway at Glamis Road and colliding with vulnerable road users.

The construction necessitates large numbers of HGV turning movements at this location which may exacerbate the existing problems.

S1.1.1 Recommendation: Traffic management layouts during construction should highlight the likelihood of HGV and plant movements at this location. Delivery drivers and site staff should be made aware of the likely increased risk of turning conflicts, particularly with vulnerable road users through inclusion in the site induction process and construction method statements.

Recommendation Accepted – Traffic management layouts at this site will highlight the likelihood of HGV and plant movement. Delivery drivers and site staff will be made aware of the likely increased risk of turning conflicts as part of the site induction. This will be included in the Code of Construction Practice at Stage 2 (Detailed Design).

2.2 Location: Glamis Road

Summary: The poor condition of existing traffic calming measures could lead to vehicle damage.

Description: Traffic calming has been installed in the form of speed cushions on Glamis Road. Some of the measures are in poor condition with missing ramps and loose / sunken blocks.

Repeated over running by construction traffic is likely to exacerbate the existing problem, to a point at which vehicles could be damaged by debris.

S1.1.2 Recommendation: Remove the traffic calming measures for the duration of the works, and reinstate at the end of the construction phase.

Recommendation Accepted – The requirement to remove the traffic calming measures on Glamis Road will be examined at Stage 2 (Detailed Design). A condition survey will be undertaken before commencement of any onsite works to verify the existing condition of the adjacent highway.

2.3 Location: Glamis Road

Summary: The poor condition of existing carriageway could lead to vehicle damage.

Description: There is an area of poor carriageway condition on Glamis Road to the north of the site access.

Repeated over running by construction traffic is likely to exacerbate the existing problem, to a point at which vehicles could be damaged by debris.

S1.1.3 Recommendation: Ensure the carriageway is maintained so as to remain safe for all users for the duration of the works.

Recommendation Accepted – This will be reviewed at Stage 2 (Detailed Design).

2.4 Location: Glamis Road

Summary: Tight swept path could result in vehicle damage.

Description: The swept path analysis for the construction layout indicates conflicts between some vehicle types approaching the site, while avoiding the parking bays on Glamis Road immediately north of the site access.

Swept path conflicts can lead to vehicle damage and could result in injuries for vehicle occupants or pedestrians if footways are over run to avoid a collision.

S1.1.4 Recommendation: Suspend additional parking bays on Glamis Road so as to ensure unobstructed egress.

Recommendation Accepted – The arrival and departure of construction vehicles to the site will be managed so as to avoid conflict on Glamis Road. The requirement to suspend additional on-street parking bays will be examined at Stage 2 (Detailed Design).

2.5 Location: Glamis Road

Summary: Gulley at the temporary site access likely to be damaged by repeated over running leading to loss of control collisions.

Description: It is proposed to open a site access on the eastern side of Glamis Road during the construction phase. There is a drainage gulley located in the channel at the kerb concurrent with the access.

Repeated over running of the gulley could result in damage which in turn could damage a tyre or wheel resulting in rapid deflation and loss of control.

S1.1.5 Recommendation: Relocate the gulley away from the access.

Recommendation Accepted – Relocation of the gulley will be examined at Stage 2 (Detailed Design).

2.6 Location: King Edward Memorial Park

Summary: Narrow diversionary path could result in pedestrian / cycle conflicts.

Description: The diversionary route for the Thames Path through the King Edward Memorial Park indicates a series of tight turns. There is no indication of the width of path to be provided.

The Thames Path through King Edward Memorial Park forms part of National Cycle Network Route 13 and the Thames Cycle Route. The path hosts joggers and pedestrians. Insufficient shared path width could result in pedestrian and cycle conflicts leading to injuries.

S1.1.6 Recommendation: Ensure the temporary path is sufficiently wide to accommodate both pedestrians and cycles, and that changes in direction have clear visibility and appropriate radii.

Recommendation Accepted – The temporary path will be of sufficient width to accommodate pedestrians and cyclists with adequate visibility being provided.

Permanent Layout

2.7 Location: Glamis Road

Summary: Tight swept path could result in vehicle damage.

Description: The swept path analysis for the construction layout indicated construction layout indicates conflicts between some vehicle types approaching the site, while avoiding the parking bays on Glamis Road immediately north of the site access.

Swept path conflicts can lead to vehicle damage and could result in injuries for vehicles occupants or pedestrians if footways are over run to avoid a collision.

S1.1.7 Recommendation: Temporary suspension of parking bays on Glamis Road may be required during maintenance periods so as to ensure unobstructed access.

Recommendation Accepted – The requirement for temporary suspension of parking bays on Glamis Road during maintenance will be reviewed at Stage 2 (Detailed Design).

3 **Response to Comments provided in addition to the Stage 1 Road Safety Audit**

3.1 Additional Comments

The Thames Path through King Edward Memorial Park forms part of National Cycle Network Route 13 and the Thames Cycle Route. Any traffic management proposed on this road should take full account of cycles. Furthermore delivery drivers should be made aware of the presence of the cycle routes and the likely increased risk of cycle / goods vehicle conflict.

Comment Response – Delivery drivers and site staff will be made aware of the presence of cyclists in the area as part of the site induction. This will be included as part of the Code of Construction Practice at Stage 2 (Detailed Design).

Thames Tideway Tunnel
Thames Water Utilities Limited



Application for Development Consent

Application Reference Number: WWO10001

Transport Assessment

Doc Ref: **7.10.18**

King Edward Memorial Park Foreshore

Figures

APFP Regulations 2009: Regulation **5(2)(q)**

Hard copy available in

Box **52** Folder **B**
January 2013

**Thames
Tideway Tunnel**



Creating a cleaner, healthier River Thames

This page is intentionally blank

Thames Tideway Tunnel

Transport Assessment

Section 21: King Edward Memorial Park Foreshore figures

List of contents

Plans	
Transport - existing highway layout	
Transport - highway layout during construction area 1	
Transport - highway layout during construction area 2	
Transport - permanent highway layout area 1 work	
Transport - highway layout during construction area 1 - vehicle swept path analysis	
Transport - highway layout during construction area 2 - vehicle swept path analysis	
Transport - permanent highway layout area 1 - vehicle swept path analysis	
Transport assessment figures	
Transport - site location plan	Figure 21.2.1
Transport - construction traffic routes	Figure 21.2.2
Transport - pedestrian and cycle network	Figure 21.4.1
Transport - public transport	Figure 21.4.2
Transport - parking	Figure 21.4.3
Transport - survey locations	Figure 21.4.4
Baseline, Construction and Development case traffic flow (AM peak hour)	Figure 21.4.5
Baseline, Construction and Development case traffic flow (PM peak hour)	Figure 21.4.6
Transport - accident locations	Figure 21.4.7
Transport - pedestrian and cyclist accidents by severity	Figure 21.4.8
Hourly Construction Lorry Movements - Site Year 1 of Construction	Figure 21.5.1

This page is intentionally blank

Plans

This page is intentionally blank

King Edward Memorial Park

THAMES TIDEWAY TUNNEL - SCHEDULE OF ASSOCIATED HIGHWAY WORKS

Drawing Number	Works Reference	Location	Item of Work	Date of Implementation
DCO-PP-24X-KEMPF-250025	PTH1X_C01	Glamis Road - north of Shadwell Pier Head access	Provision of gated construction site access at the location of an existing vehicle access to the Trees for Cities depot. The existing access will be widened to accommodate HGVs and dropped kerbs and tactile paving will also be provided.	TBC
	PTH1X_C02	Glamis Road - north of Peartree Lane	Suspension of on-street parking opposite the construction site access.	TBC
	PTH1X_C03	Glamis Road / The Highway junction	Relocation of the stop line, signal head and the advanced cycle stop line on the Glamis Road arm of the Glamis Road / The Highway junction.	TBC
DCO-PP-24X-KEMPF-250026	PTH1X_C04	Construction site access road	Provision of crossing point for pedestrians wishing to access the river front from the park. This access will be gated and the pedestrian crossing managed during the operating hours of the site.	TBC
DCO-PP-24X-KEMPF-250027	PTH1X_P01	Glamis Road - north of Shadwell Pier Head access	Retention of the gated construction site access which will be used by maintenance vehicles during the operational phase.	TBC
	PTH1X_P02	Glamis Road - north of Peartree Lane	Reinstatement of the on-street parking on the western side of Glamis Road.	TBC
	PTH1X_P03	Glamis Road / The Highway junction	Reinstatement of the stopline and advanced cycle stop line to its existing location.	TBC

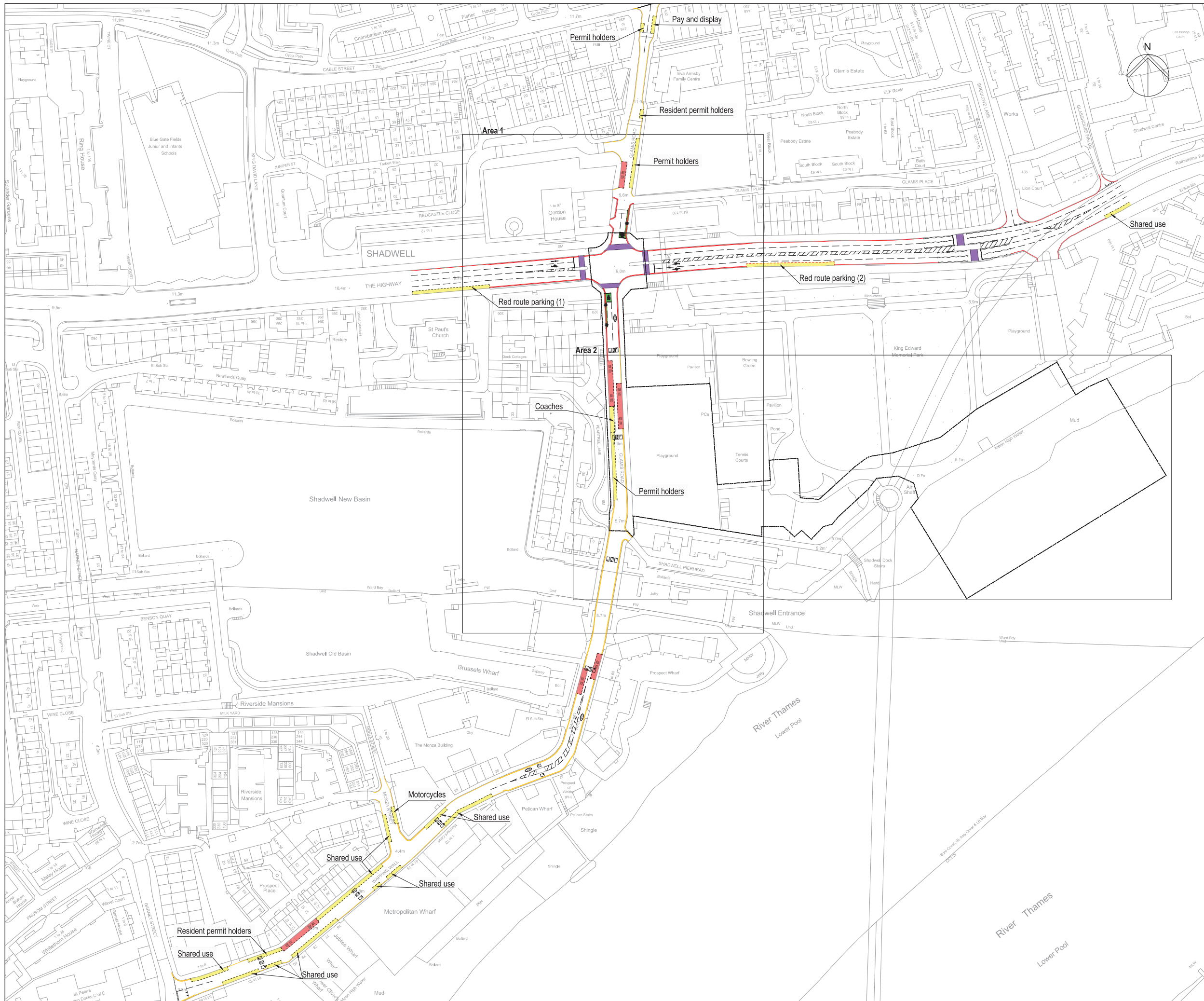

Mapping reproduced by permission of Ordnance Survey on behalf of HMSO. © Crown Copyright and Database right 2012. All rights reserved. Ordnance Survey licence number 100019345

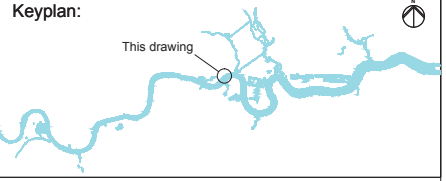

Coordinates are to be Ordnance Survey Datum OSGB36. All levels are in metres and relate to the Tunnel Datum which is 100 metres below Ordnance Datum Newlyn.

- Key**
- Existing
 - Red route parking restrictions
 - Parking restrictions
 - On street parking
 - Bus stop / stand
 - Pedestrian crossing
 - Cycle lane / advance stop line
- Revised
- Limit of land to be acquired or used (LLAU)

- On Street Parking**
- Permit holders - C4 Permit holders only Mon - Fri 8.30am - 5.30pm**
 - Coaches - Coaches only. Max stay 4 hours**
 - Shared use - C4 Permit holders or pay and display max stay 4 hours Mon - Fri 8.30am - 5.30pm**
 - Motorcycles - Solo motorcycles only**
 - Resident permit holders - C4 Resident permit holders only Mon - Fri 8.30am - 5.30pm**
 - Red route parking (1) - Mon - Sat 7am - 7pm 1 hour no return within 2 hours**
 - Red route parking (2) - Mon - Sat 10am - 4pm 1 hour no return within 2 hours**
 - Pay and display - Mon - Fri 8.30am - 5.30pm**

Stage
Existing and construction base case

- Standards**
- Design Manual For Roads And Bridges, Dft, 1992
 - Traffic Signs Regulations & General Directions, Tso, 2002
 - Traffic Signs Manual, Dft, 2006
 - Manual For Streets, Dft, 2007
 - Manual For Streets 2, Cilt, 2010
 - Designing For Deliveries, Fta, 1998
 - Cycle Infrastructure Design Ltn 2/08, Dft, 2008
 - Design Of Pedestrian Crossings Ltn 2/95, Dft, 1995
 - Guidance For The Use Of Tactile Paving, Dft, 1998
 - Accessible Bus Stop Design Guidance, TfL, 2006

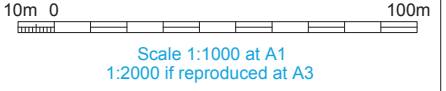

FOR INFORMATION

Location
King Edward Memorial Park Foreshore
London Borough of Tower Hamlets

Document Information
Application for Development Consent
Existing highway layout

DCO-PP-24X-KEMPF-250024
January 2013



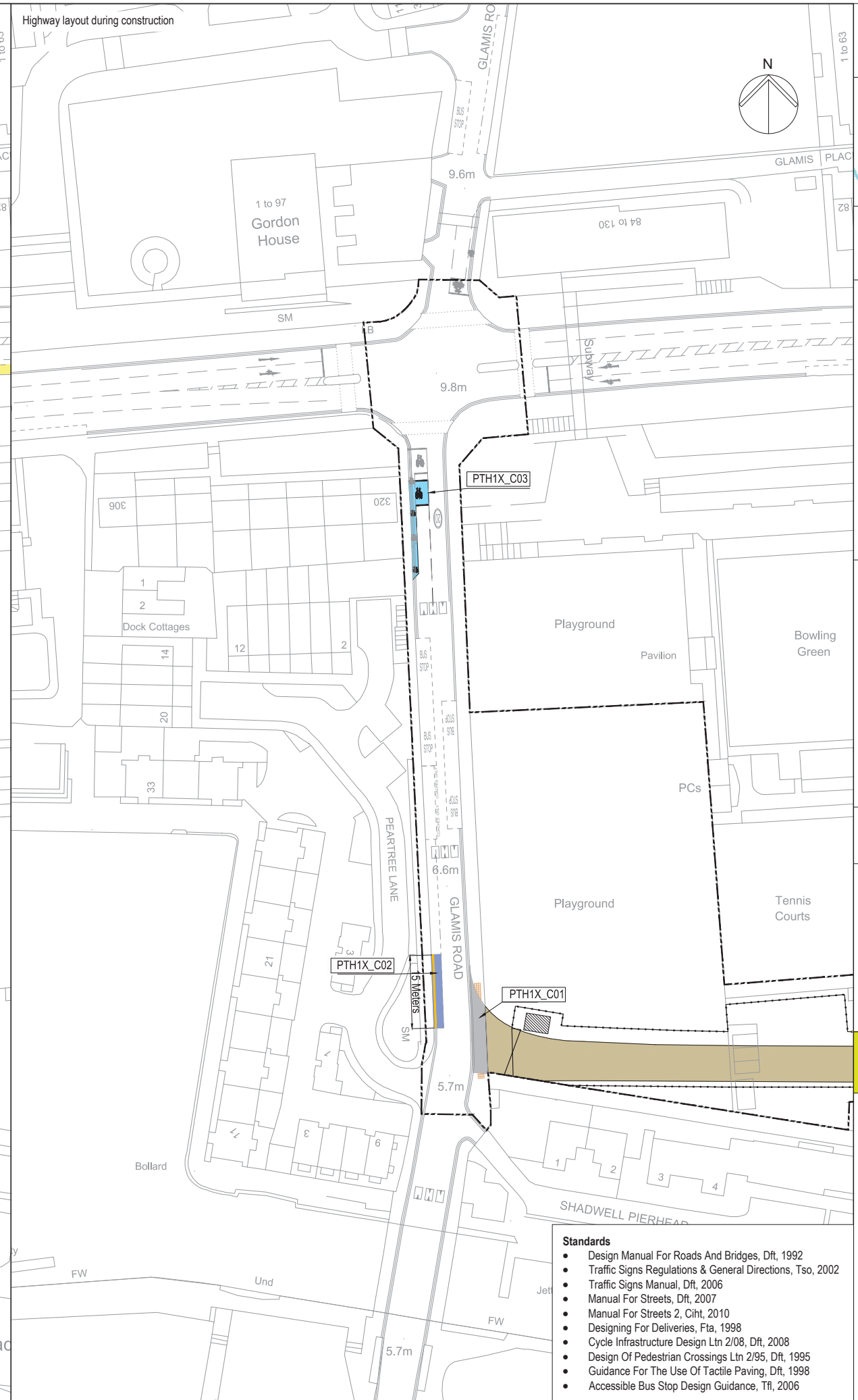
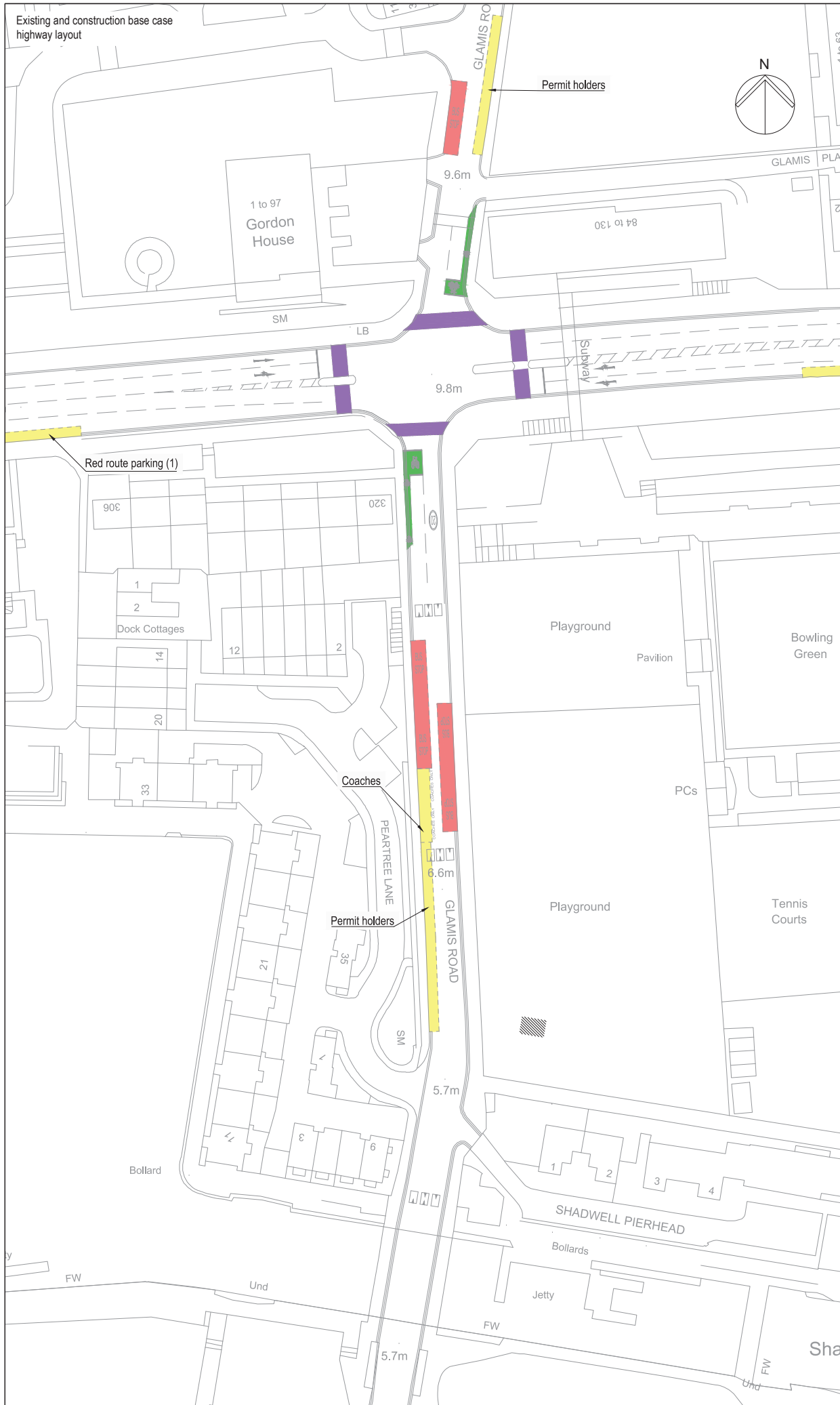

Mapping reproduced by permission of Ordnance Survey on behalf of HMSO. © Crown Copyright and Database right 2012. All rights reserved. Ordnance Survey licence number 100019345

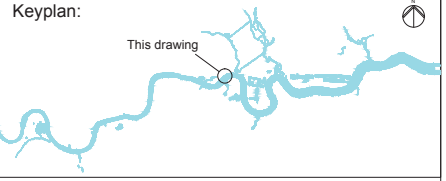

Coordinates are to be Ordnance Survey Datum OSGB36. All levels are in metres and relate to the Tunnel Datum which is 100 metres below Ordnance Datum Newlyn.

Key	
Existing	
	Parking restrictions
	On street parking
	Bus stop / stand
	Pedestrian crossing
	Cycle lane / advance stop line
Revised	
	Parking restriction
	Removal of footway
	Suspended on-street parking
	Relocated advanced stop line
	Illustrative on-site manoeuvring zone
	Site hut
	Site hoarding
	Access gate
	Tactile paving
	Limit of land to be acquired or used (LLAU)
	PTH1X_C00 See schedule of works

On Street Parking
 Permit holders - C4 Permit holders only Mon - Fri 8.30am - 5.30pm
 Coaches - Coaches only. Max stay 4 hours
 Shared use - C4 Permit holders or pay and display max stay 4 hours Mon - Fri 8.30am - 5.30pm
 Motorcycles - Solo motorcycles only
 Resident permit holders - C4 Resident permit holders only Mon - Fri 8.30am - 5.30pm
 Red route parking (1) - Mon - Sat 7am - 7pm 1 hour no return within 2 hours
 Red route parking (2) - Mon - Sat 10am - 4pm 1 hour no return within 2 hours
 Pay and display - Mon - Fri 8.30am - 5.30pm

Stage
 Phase 1-3

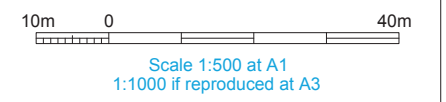

ILLUSTRATIVE

Location
 King Edward Memorial Park Foreshore
 London Borough of Tower Hamlets

Document Information
 Application for Development Consent
 Highway layout during construction (Area 1)

- Standards**
- Design Manual For Roads And Bridges, Dft, 1992
 - Traffic Signs Regulations & General Directions, Tso, 2002
 - Traffic Signs Manual, Dft, 2006
 - Manual For Streets, Dft, 2007
 - Manual For Streets 2, Cihl, 2010
 - Designing For Deliveries, Fta, 1998
 - Cycle Infrastructure Design Ltn 2/08, Dft, 2008
 - Design Of Pedestrian Crossings Ltn 2/95, Dft, 1995
 - Guidance For The Use Of Tactile Paving, Dft, 1998
 - Accessible Bus Stop Design Guidance, TfL, 2006

DCO-PP-24X-KEMPF-250025
 January 2013

© Thames Water Utilities Ltd 2008

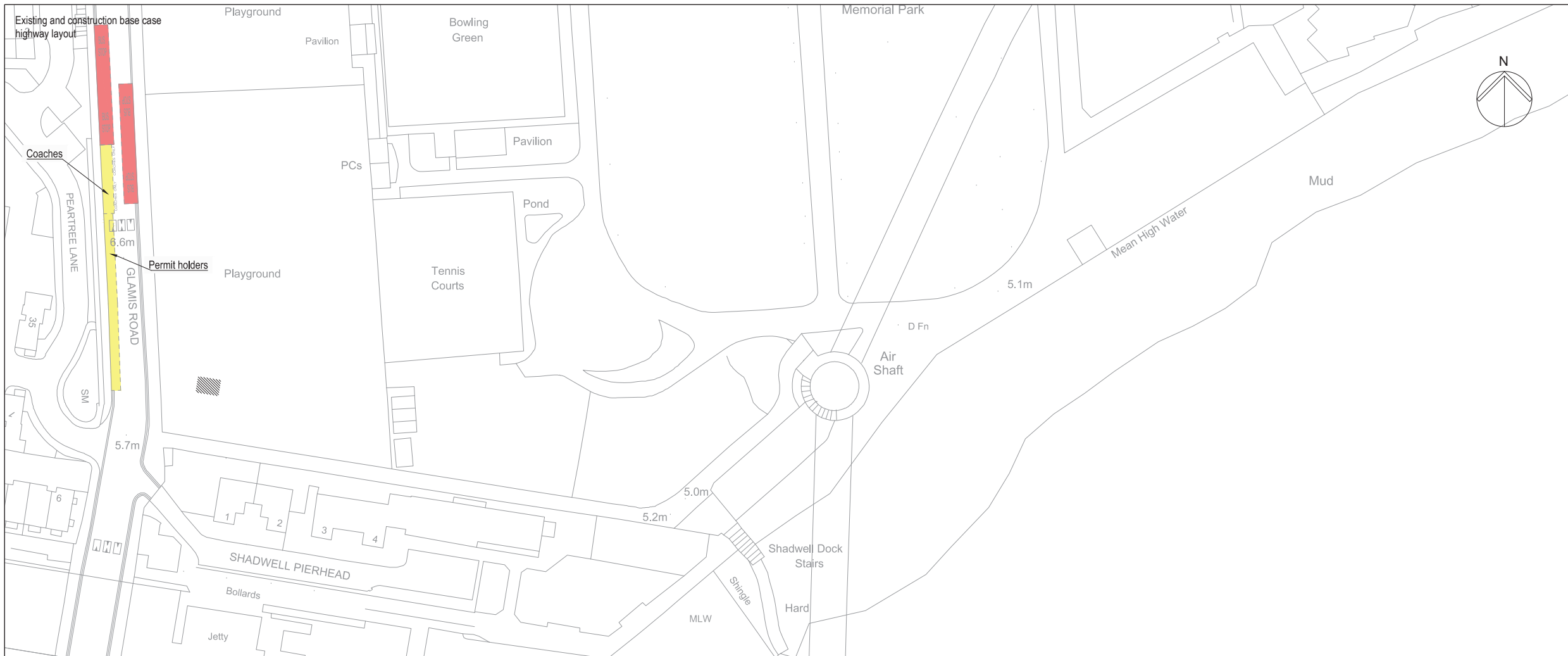

Mapping reproduced by permission of Ordnance Survey on behalf of HMSO. © Crown Copyright and Database right 2012. All rights reserved. Ordnance Survey licence number 100019345

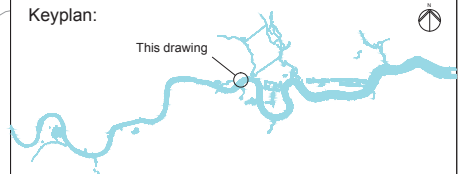

Coordinates are to be Ordnance Survey Datum OSGB36. All levels are in metres and relate to the Tunnel Datum which is 100 metres below Ordnance Datum Newlyn.

Key	
Existing	
	Parking restrictions
	On street parking
	Bus stop / stand
	Pedestrian crossing
	Cycle lane / advance stop line
Revised	
	Parking restrictions
	Removal of footway
	Illustrative on-site manoeuvring zone
	Suspended on street parking
	Tactile paving
	Site hut
	Site hoarding
	Access gate
	Limit of land to be acquired or used (LLAU)
	See schedule of works

On Street Parking
 Permit holders - C4 Permit holders only Mon - Fri 8.30am - 5.30pm
 Coaches - Coaches only. Max stay 4 hours
 Shared use - C4 permit holders or pay and display max stay 4 hours Mon - Fri 8.30am - 5.30pm
 Motorcycles - Solo motorcycles only
 Resident permit holders - C4 resident permit holders only Mon - Fri 8.30am - 5.30pm
 Red route parking (1) - Mon - Sat 7am - 7pm 1 hour no return within 2 hours
 Red route parking (2) - Mon - Sat 10am - 4pm 1 hour no return within 2 hours
 Pay and display - Mon - Fri 8.30am - 5.30pm

Stage
Phase 1-3

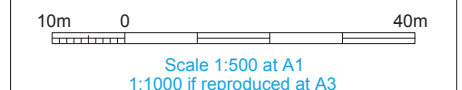

ILLUSTRATIVE

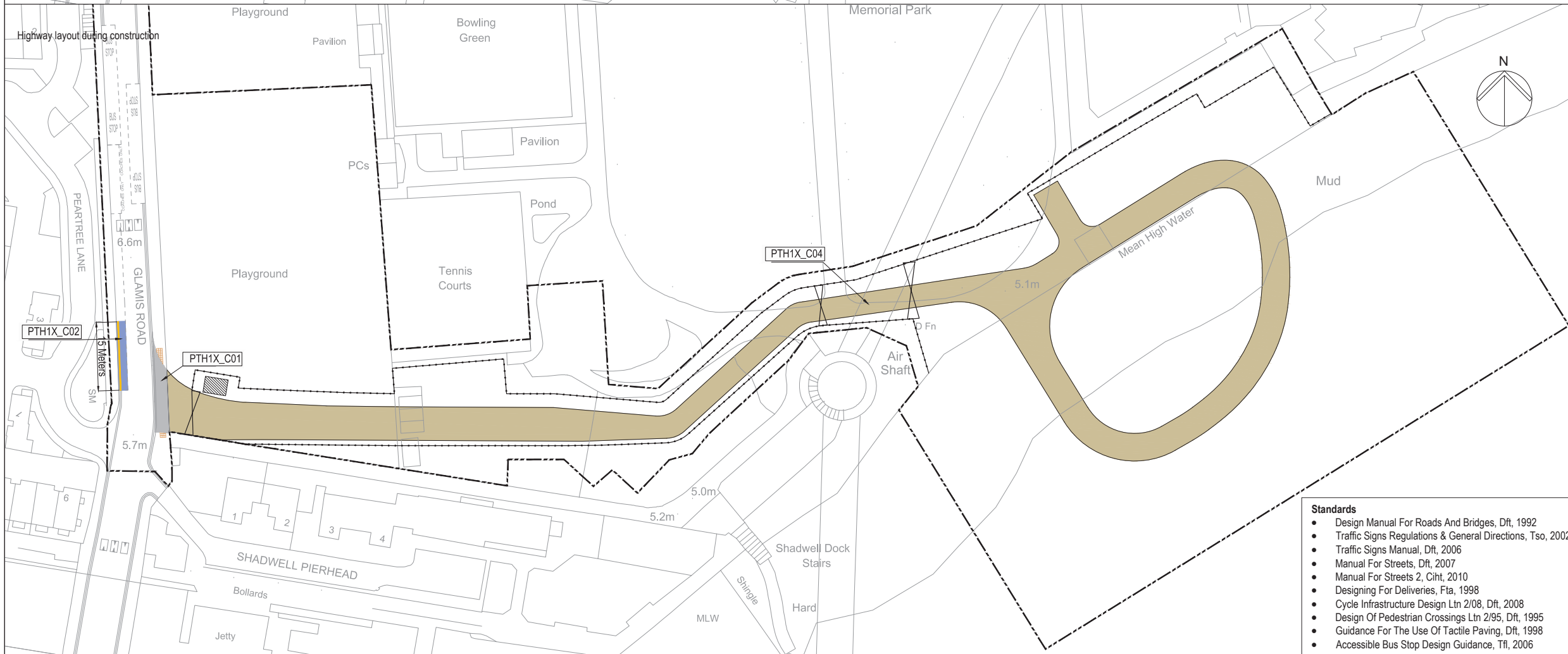

- Standards**
- Design Manual For Roads And Bridges, Dft, 1992
 - Traffic Signs Regulations & General Directions, Tso, 2002
 - Traffic Signs Manual, Dft, 2006
 - Manual For Streets, Dft, 2007
 - Manual For Streets 2, Cihl, 2010
 - Designing For Deliveries, Fta, 1998
 - Cycle Infrastructure Design Ltn 2/08, Dft, 2008
 - Design Of Pedestrian Crossings Ltn 2/95, Dft, 1995
 - Guidance For The Use Of Tactile Paving, Dft, 1998
 - Accessible Bus Stop Design Guidance, TfL, 2006

Location
King Edward Memorial Park Foreshore
London Borough of Tower Hamlets

Document Information
Application for Development Consent
Highway layout during construction (Area 2)

DCO-PP-24X-KEMPF-250026
January 2013



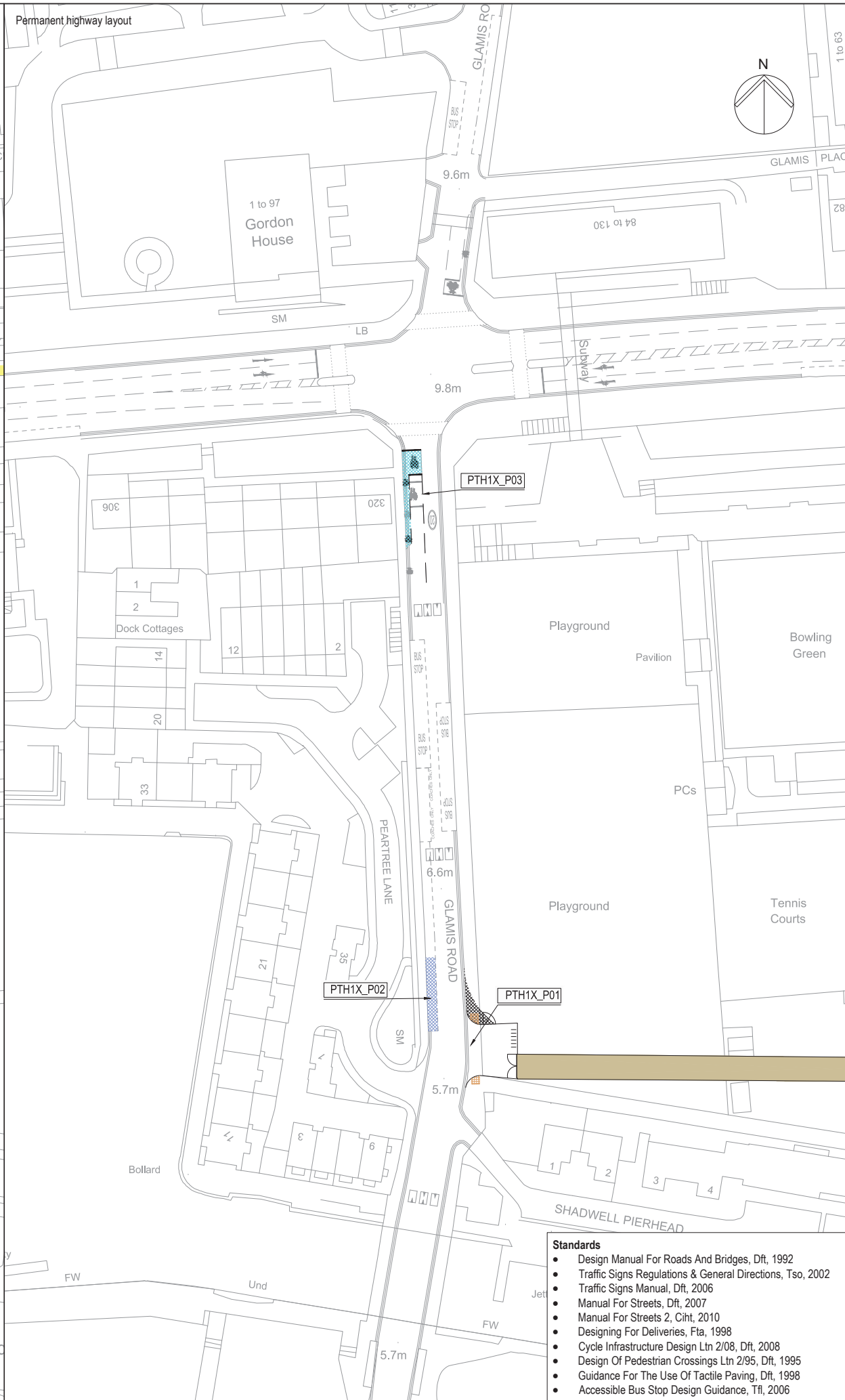
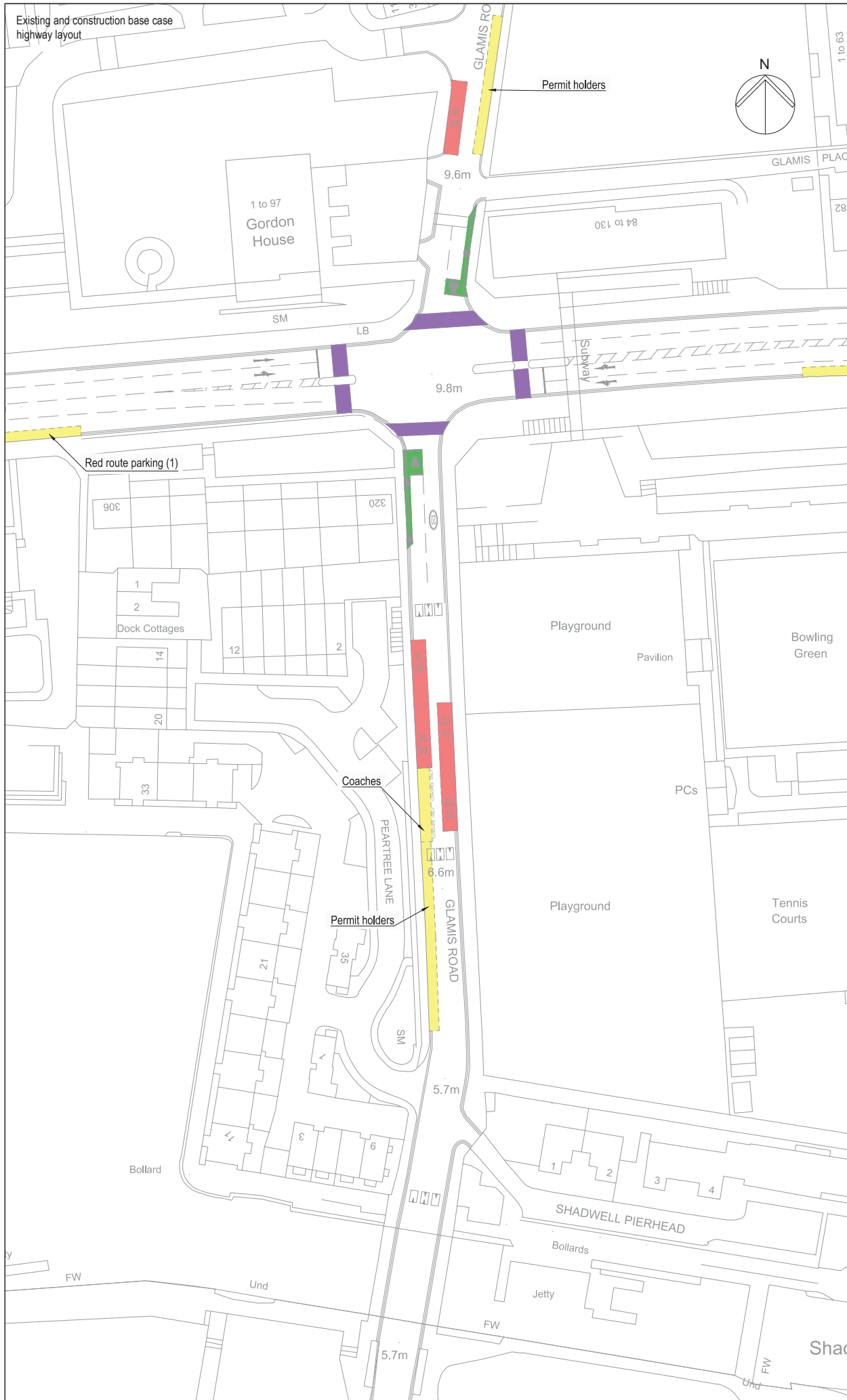

Mapping reproduced by permission of Ordnance Survey on behalf of HMSO. © Crown Copyright and Database right 2012. All rights reserved. Ordnance Survey licence number 100019345

Keyplan:

Coordinates are to be Ordnance Survey Datum OSGB36. All levels are in metres and relate to the Tunnel Datum which is 100 metres below Ordnance Datum Newlyn.

Key

Existing	Parking restrictions
On street parking	On street parking
Bus stop / stand	Bus stop / stand
Pedestrian crossing	Pedestrian crossing
Cycle lane / advance stop line	Cycle lane / advance stop line
Revised	Reinstated parking
Reinstated parking	Reinstated advance stop line
Reinstated advance stop line	Reinstated footway
Reinstated footway	Tactile paving
Tactile paving	Bicycle parking
Bicycle parking	Permanent access
Permanent access	See schedule of works

On Street Parking

Permit holders - C4 Permit holders only Mon - Fri 8.30am - 5.30pm

Coaches - Coaches only. Max stay 4 hours

Shared use - C4 Permit holders or pay and display max stay 4 hours Mon - Fri 8.30am - 5.30pm

Motorcycles - Solo motorcycles only

Resident permit holders - C4 Resident permit holders only Mon - Fri 8.30am - 5.30pm

Red route parking (1) - Mon - Sat 7am - 7pm 1 hour no return within 2 hours

Red route parking (2) - Mon - Sat 10am - 4pm 1 hour no return within 2 hours

Pay and display - Mon - Fri 8.30am - 5.30pm

Stage

Permanent phase

10m 0 40m

Scale 1:500 at A1
1:1000 if reproduced at A3

ILLUSTRATIVE

Location

King Edward Memorial Park Foreshore
London Borough of Tower Hamlets

Document Information

Application for Development Consent
Permanent highway layout - Area 1 work

DCO-PP-24X-KEMPF-250027
January 2013

Standards

- Design Manual For Roads And Bridges, Dft, 1992
- Traffic Signs Regulations & General Directions, Tso, 2002
- Traffic Signs Manual, Dft, 2006
- Manual For Streets, Dft, 2007
- Manual For Streets 2, Cihl, 2010
- Designing For Deliveries, Fta, 1998
- Cycle Infrastructure Design Ltn 2/08, Dft, 2008
- Design Of Pedestrian Crossings Ltn 2/95, Dft, 1995
- Guidance For The Use Of Tactile Paving, Dft, 1998
- Accessible Bus Stop Design Guidance, TfL, 2006

Thames Tideway Tunnel
Creating a cleaner, healthier River Thames

Thames Water

© Thames Water Utilities Ltd 2008

16.5m Articulated Vehicle
Speed = 20km/h leaving site
10km/h arriving at site

12.0m Rigid Vehicle
Speed = 20km/h leaving site
15km/h arriving at site

Mapping reproduced by permission of Ordnance Survey on behalf of HMSO. © Crown Copyright and Database right 2012. All rights reserved. Ordnance Survey licence number 100019345

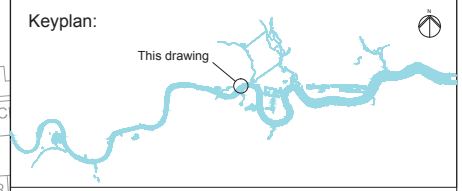

Coordinates are to be Ordnance Survey Datum OSGB36. All levels are in metres and relate to the Tunnel Datum which is 100 metres below Ordnance Datum Newlyn.

- Key**
- Existing**
- Parking restrictions
 - On street parking
 - Bus stop / stand
 - Cycle lane / advance stop line
 - Pedestrian crossing
- Revised**
- Parking restriction
 - Removal of footway
 - Suspended on street parking
 - Relocated advance stopline
 - Illustrative on-site manoeuvring zone
 - Security hut
 - Site hoarding
 - Access gate
 - Limit of land to be acquired or used (LLAU)
- Vehicle swept path analysis**
- Vehicle body outlines
 - Vehicle chassis outline
 - Vehicle swept path

- Standards**
- Design Manual For Roads And Bridges, Dft, 1992
 - Traffic Signs Regulations & General Directions, Tso, 2002
 - Traffic Signs Manual, Dft, 2006
 - Manual For Streets, Dft, 2007
 - Manual For Streets 2, Cihl, 2010
 - Designing For Deliveries, Fta, 1998
 - Cycle Infrastructure Design Ltn 2/08, Dft, 2008
 - Design Of Pedestrian Crossings Ltn 2/95, Dft, 1995
 - Guidance For The Use Of Tactile Paving, Dft, 1998
 - Accessible Bus Stop Design Guidance, TfL, 2006

Stage
Phase 1-3

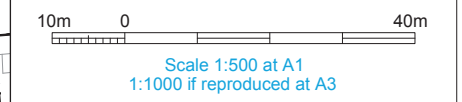

ILLUSTRATIVE

Location
King Edward Memorial Park Foreshore
London Borough of Tower Hamlets

Document Information
Application for Development Consent
Highway layout during construction (Area 1)
Vehicle swept path analysis

DCO-PP-24X-KEMPF-250028
January 2013



16.5m Articulated Vehicle

Max Legal Articulated Vehicle (16.5m)	
Overall Length	16.500m
Overall Width	2.500m
Overall Body Height	3.632m
Min Body Ground Clearance	0.396m
Max Track Width	2.500m
Lock to Lock Time	6.00 sec
Kerb to Kerb Turning Radius	6.870m

12.0m Rigid Vehicle

Rigid Truck	
Overall Length	12.000m
Overall Width	2.500m
Overall Body Height	3.928m
Min Body Ground Clearance	0.412m
Track Width	2.471m
Lock to Lock Time	6.00 sec
Kerb to Kerb Turning Radius	11.900m

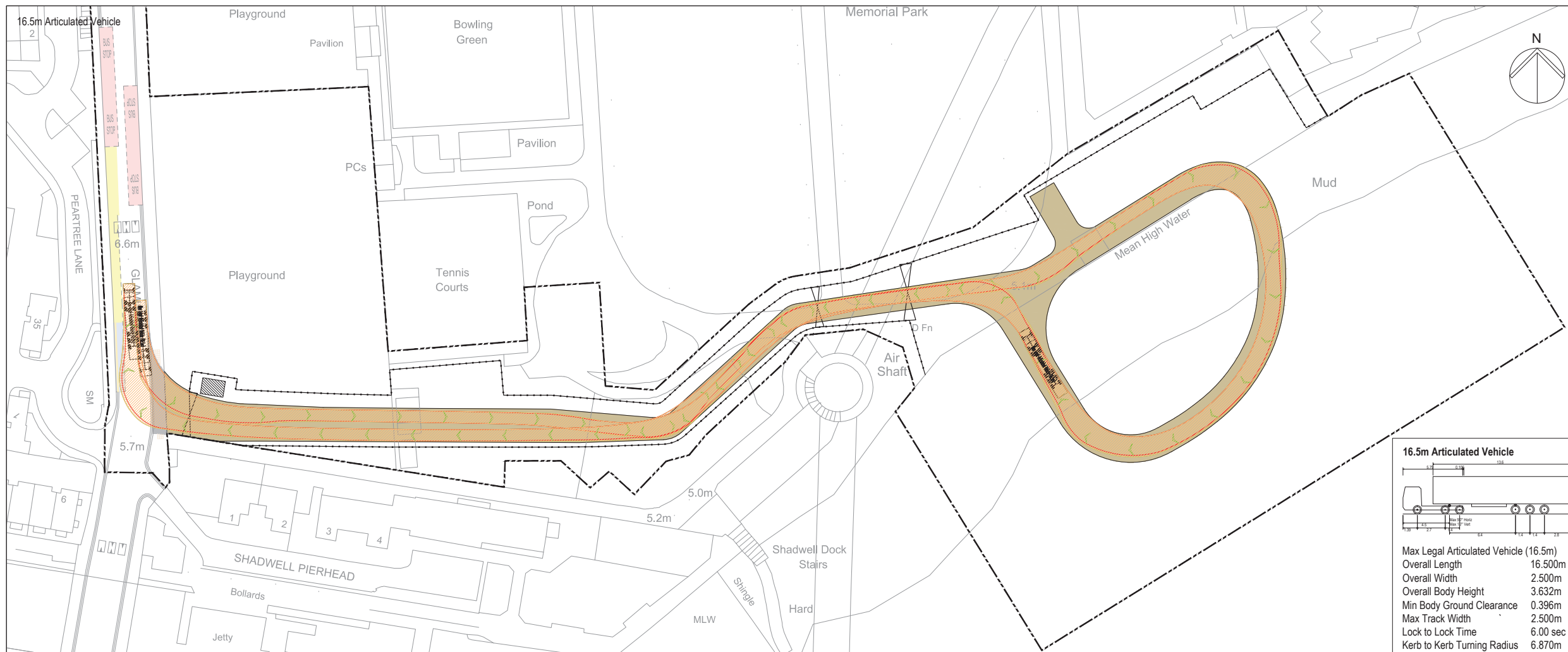

16.5m Articulated Vehicle

Max Legal Articulated Vehicle (16.5m)	Overall Length	16.500m
	Overall Width	2.500m
	Overall Body Height	3.632m
	Min Body Ground Clearance	0.396m
	Max Track Width	2.500m
	Lock to Lock Time	6.00 sec
	Kerb to Kerb Turning Radius	6.870m

Mapping reproduced by permission of Ordnance Survey on behalf of HMSO. © Crown Copyright and Database right 2012. All rights reserved. Ordnance Survey licence number 100019345

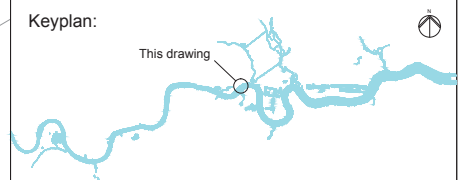

Coordinates are to be Ordnance Survey Datum OSGB36. All levels are in metres and relate to the Tunnel Datum which is 100 metres below Ordnance Datum Newlyn.

- Key**
- Existing
- Parking restrictions
 - On street parking
 - Bus stop / stand
- Revised
- Parking restrictions
 - Removal of footway
 - Suspended on street parking
 - Illustrative on-site manoeuvring zone
 - Security hut
 - Site hoarding
 - Access gate
 - Limit of land to be acquired or used (LLAU)
- Vehicle swept path analysis
- Vehicle body outlines
 - Vehicle chassis outline
 - Vehicle swept path

- Standards**
- Design Manual For Roads And Bridges, Dft, 1992
 - Traffic Signs Regulations & General Directions, Tso, 2002
 - Traffic Signs Manual, Dft, 2006
 - Manual For Streets, Dft, 2007
 - Manual For Streets 2, Cihl, 2010
 - Designing For Deliveries, Fta, 1998
 - Cycle Infrastructure Design Ltn 2/08, Dft, 2008
 - Design Of Pedestrian Crossings Ltn 2/95, Dft, 1995
 - Guidance For The Use Of Tactile Paving, Dft, 1998
 - Accessible Bus Stop Design Guidance, TfL, 2006

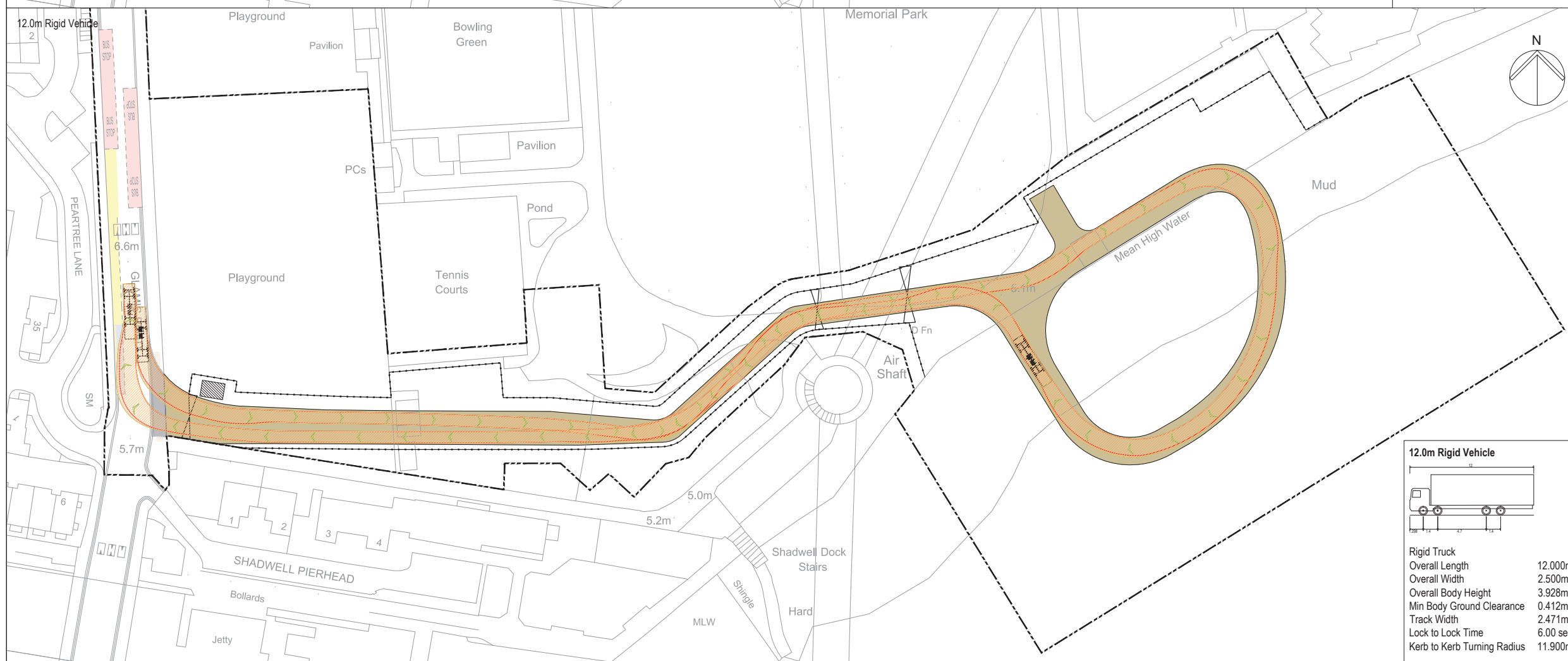

12.0m Rigid Vehicle

Rigid Truck	Overall Length	12.000m
	Overall Width	2.500m
	Overall Body Height	3.928m
	Min Body Ground Clearance	0.412m
	Track Width	2.471m
	Lock to Lock Time	6.00 sec
	Kerb to Kerb Turning Radius	11.900m

Stage
Phase 1-3

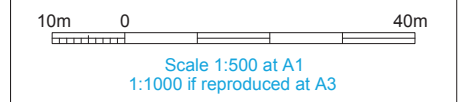

ILLUSTRATIVE

Location
King Edward Memorial Park Foreshore
London Borough of Tower Hamlets

Document Information
Application for Development Consent
Highway layout during construction (Area 2)
Vehicle swept path analysis

DCO-PP-24X-KEMPF-250029
January 2013





Mapping reproduced by permission of Ordnance Survey on behalf of HMSO. © Crown Copyright and Database right 2012. All rights reserved. Ordnance Survey licence number 100019345

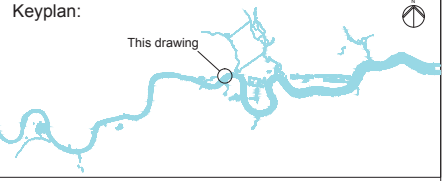

Coordinates are to be Ordnance Survey Datum OSGB36. All levels are in metres and relate to the Tunnel Datum which is 100 metres below Ordnance Datum Newlyn.

- Key**
- Existing**
- Parking restrictions
 - On street parking
 - Bus stop / stand
 - Cycle lane / advance stop line
 - Pedestrian crossing
- Revised**
- Permanent access
 - Bicycle parking
- Vehicle swept path analysis**
- Vehicle body outlines
 - Vehicle chassis outline
 - Vehicle swept path

- Standards**
- Design Manual For Roads And Bridges, Dft, 1992
 - Traffic Signs Regulations & General Directions, Tso, 2002
 - Traffic Signs Manual, Dft, 2006
 - Manual For Streets, Dft, 2007
 - Manual For Streets 2, Cihl, 2010
 - Designing For Deliveries, Fta, 1998
 - Cycle Infrastructure Design Ltn 2/08, Dft, 2008
 - Design Of Pedestrian Crossings Ltn 2/95, Dft, 1995
 - Guidance For The Use Of Tactile Paving, Dft, 1998
 - Accessible Bus Stop Design Guidance, TfL, 2006

Stage
Permanent phase

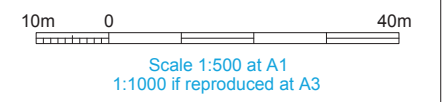

ILLUSTRATIVE

Location
King Edward Memorial Park Foreshore
London Borough of Tower Hamlets

Document Information
Application for Development Consent
Permanent highway layout (Area 1)
Vehicle swept path analysis

DCO-PP-24X-KEMPP-250030
January 2013



10.7m Small Articulated Vehicle

Small Articulated Vehicle	10.700m
Overall Length	2.360m
Overall Width	3.604m
Overall Body Height	0.382m
Min Body Ground Clearance	2.240m
Track Width	6.00 sec
Lock to Lock Time	5.740m
Kerb to Kerb Turning Radius	

10.0m Rigid Vehicle

FTA Design HG Rigid Vehicle (1998)	10.000m
Overall Length	2.500m
Overall Width	3.645m
Overall Body Height	0.440m
Min Body Ground Clearance	2.470m
Track Width	3.00 sec
Lock to Lock Time	11.000m
Kerb to Kerb Turning Radius	

11.36m Liebherr Ltm 1055-3.1 Mobile Crane

Liebherr LTM 1055-3.1 Mobile Crane	11.360m
Overall Length	2.820m
Overall Width	3.733m
Overall Body Height	0.353m
Min Body Ground Clearance	2.820m
Track Width	4.00 sec
Lock to Lock Time	8.170m
Wall to Wall Turning Radius	

Transport assessment figures

This page is intentionally blank



- Key**
- TFL road network
 - Limits of Land to be Acquired or Used
 - Local authority boundary

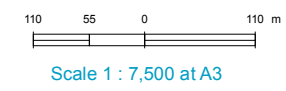

FOR INFORMATION

Location
King Edward Memorial Park Foreshore
 London Borough of Tower Hamlets

Document Information
Transport Assessment
 Transport - site location plan

Figure 21.2.1
 1PL03-TT-50614
 January 2013





- Key**
- * Site access
 - TFL road network
 - Primary construction route
 - Limits of Land to be Acquired or Used
 - Local authority boundary

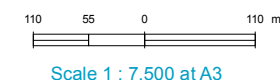

FOR INFORMATION

Location
King Edward Memorial Park Foreshore
 London Borough of Tower Hamlets

Document Information
Transport Assessment
 Transport - construction traffic routes

Figure 21.2.2
 1PL03-TT-50606
 January 2013

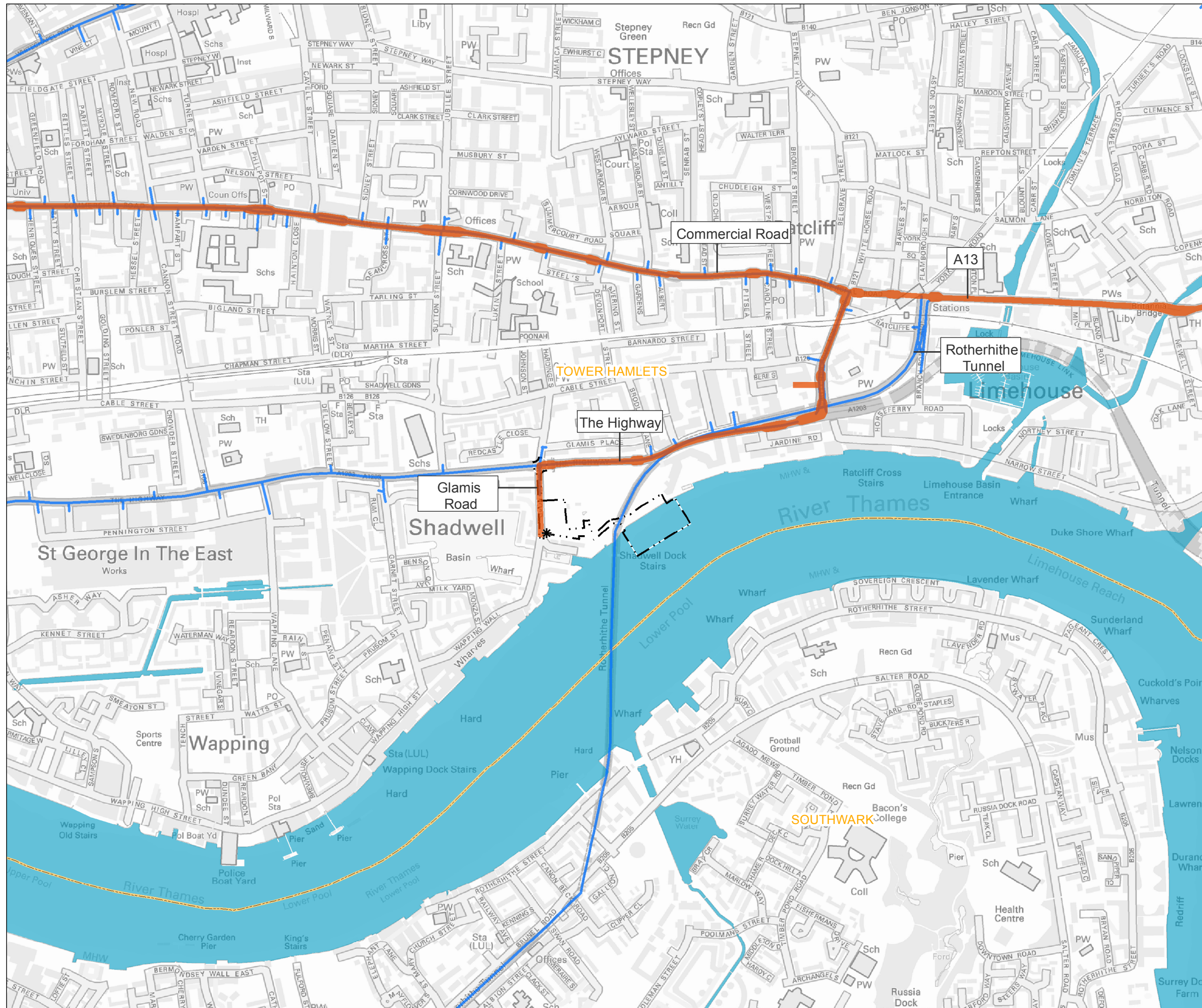

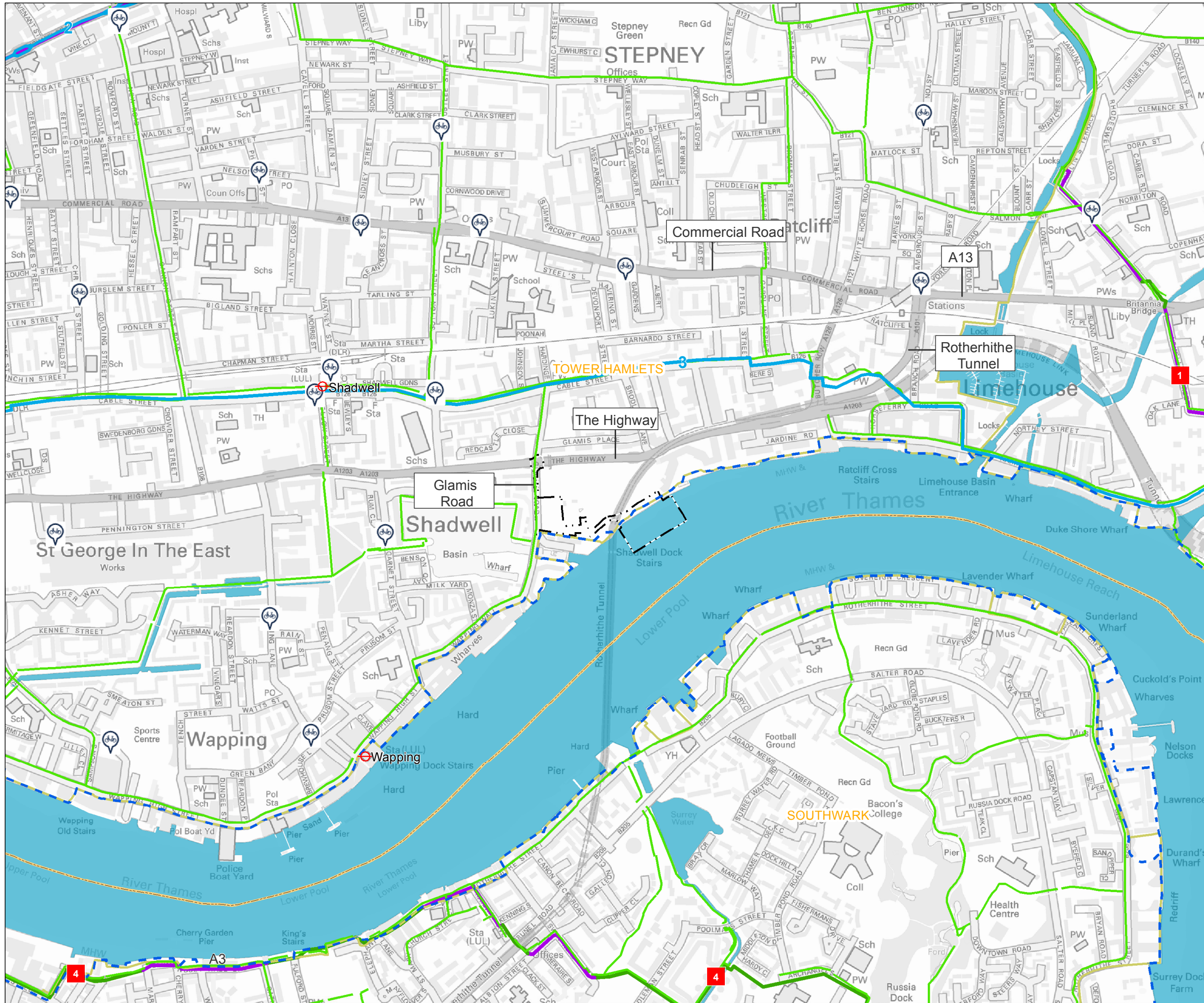

Mapping reproduced by permission of Ordnance Survey on behalf of HMSO. © Crown Copyright and Database right 2012. All rights reserved. Ordnance Survey licence number 100019345



- Key**
- Underground stations with cycle parking
 - Barclays cycle hire locations
 - Cycle superhighway (open)
 - Thames path
 - London cycle routes
 - London strategic walk network
 - National cycle network
 - Route Type**
 - Open Traffic Free
 - Open on-road
 - Limits of Land to be Acquired or Used
 - Local authority boundary

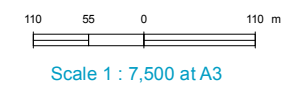

FOR INFORMATION

Location
King Edward Memorial Park Foreshore
 London Borough of Tower Hamlets

Document Information
Transport Assessment
 Transport - pedestrian and cycle network

Figure 21.4.1
 1PL03-TT-50622
 January 2013





- Key**
- TFL bus stops
 - National rail stations
 - London underground stations
 - Docklands light railway stations
 - London overground stations
 - Pier locations
 - TFL bus routes
 - Limits of Land to be Acquired or Used
 - Local authority boundary

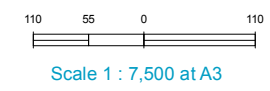

FOR INFORMATION

Location
King Edward Memorial Park Foreshore
 London Borough of Tower Hamlets

Document Information
Transport Assessment
 Transport - public transport

Figure 21.4.2
 1PL03-TT-50630
 January 2013

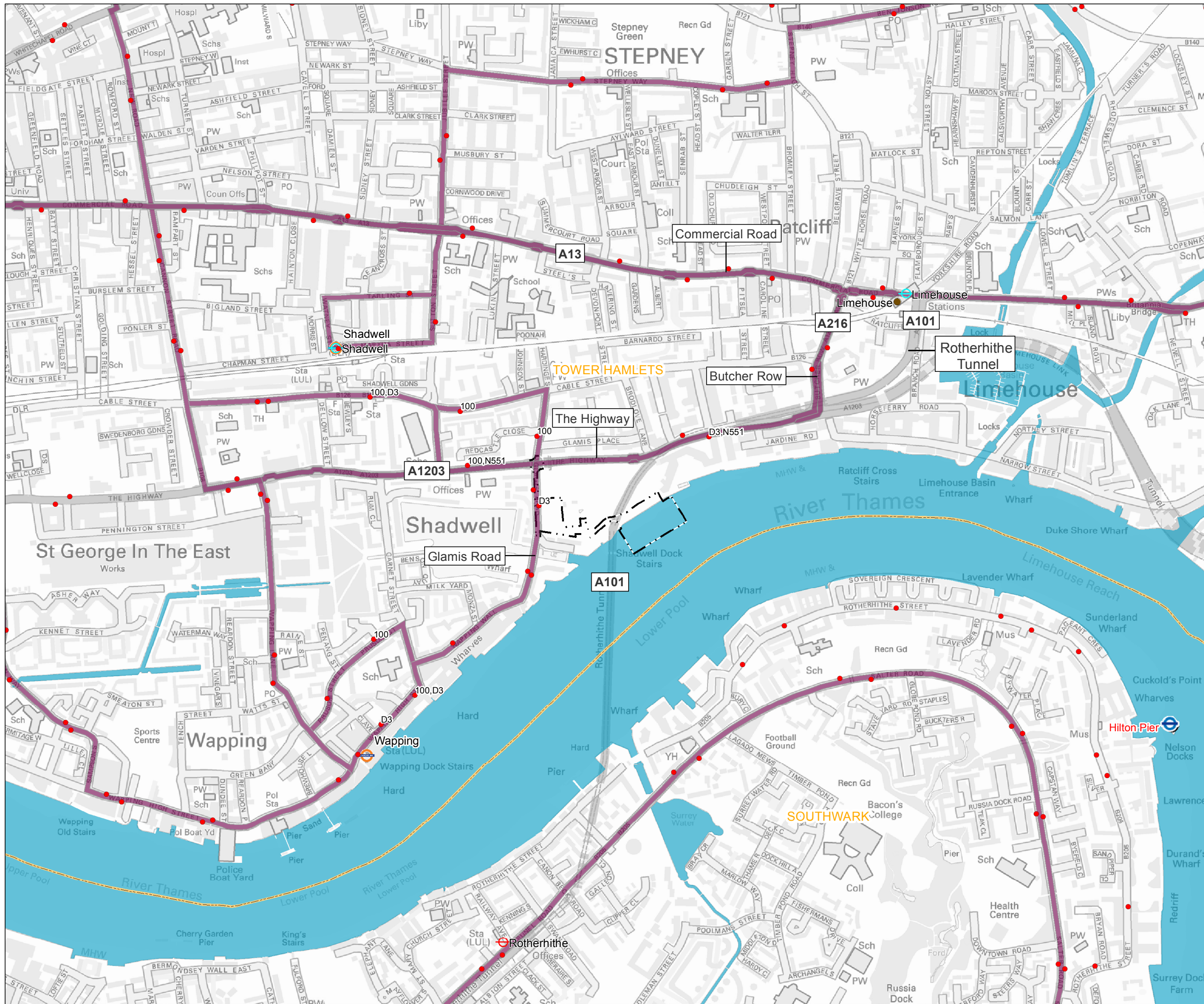



- Key**
- Private car parking
 - Coach parking
 - City Car
 - City Car (Coming Soon)
 - Hertz on Demand
 - Zip Car
 - Controlled Parking Zones and hours of operation
 - Limits of Land to be Acquired or Used
 - Local authority boundary



Scale 1 : 7,500 at A3

FOR INFORMATION

Location
King Edward Memorial Park Foreshore
 London Borough of Tower Hamlets

Document Information
Transport Assessment
 Transport - parking

Figure 21.4.3
 1PL03-TT-50638
 January 2013

Thames Tideway Tunnel
 Creating a cleaner, healthier River Thames

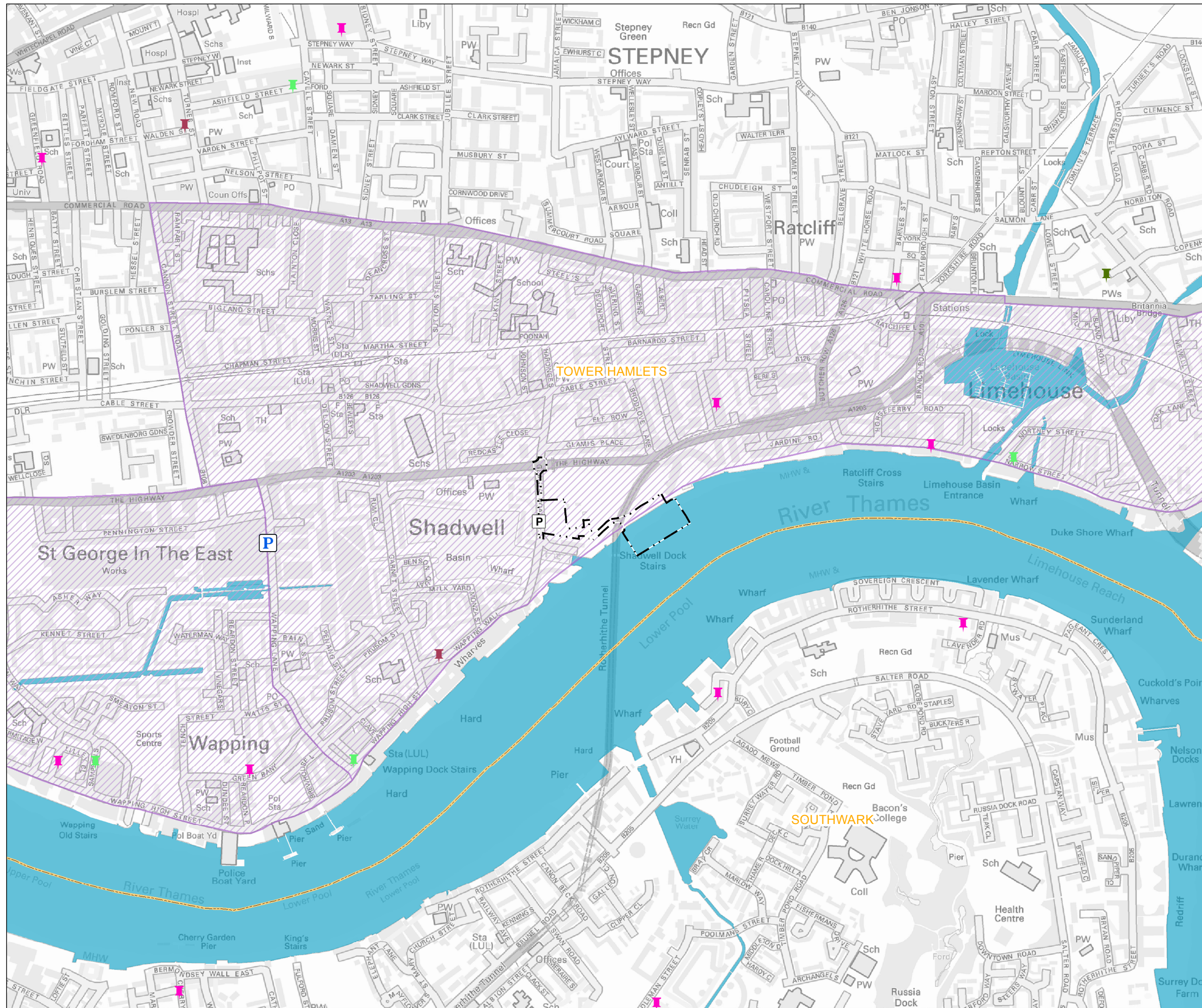

Mapping reproduced by permission of Ordnance Survey on behalf of HMSO. © Crown Copyright and Database right 2012. All rights reserved. Ordnance Survey licence number 100019345



- Key**
- Automatic traffic count surveys
 - Pedestrian and cycle surveys
 - Junction surveys
 - Parking surveys
 - Limits of Land to be Acquired or Used
 - Local authority boundary

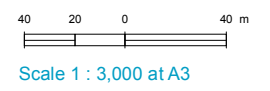
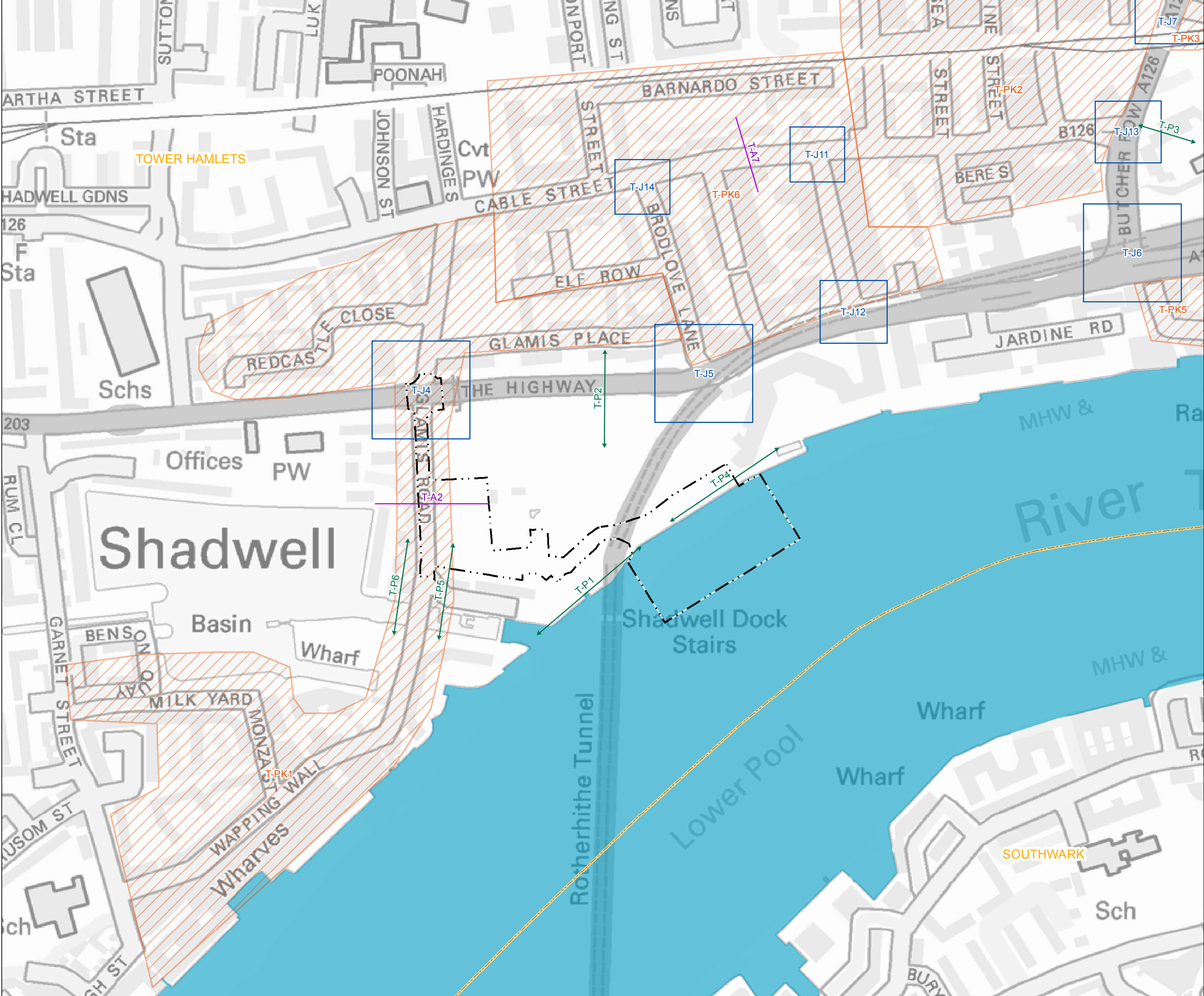

FOR INFORMATION

Location
 King Edward Memorial Park Foreshore
 London Borough of Tower Hamlets

Document Information
 Transport Assessment
 Transport - survey locations

Figure 21.4.4
 1PL03-TT-50646
 January 2013



Site: KEMP
 Borough: Tower Hamlets
 Junction: The Highway/ Glamis Rd
 Junction no.: PBA 28

Key

	Baseline
	Construction Base
	Development Case

Data: Traffic Flow in PCUs - AM Peak Hour
 from Traffic Survey

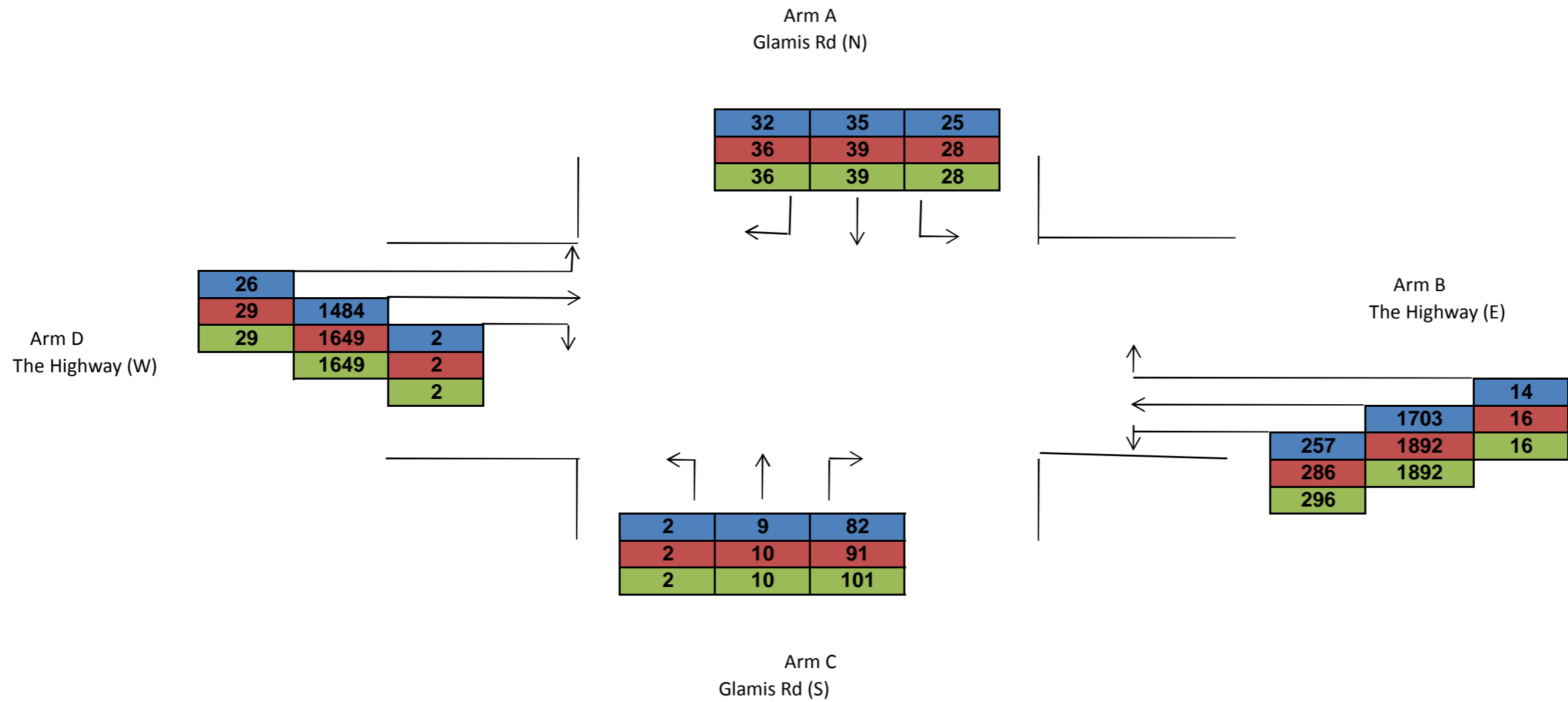

FOR INFORMATION

Location
 King Edward Memorial Park
 London Borough of Tower Hamlets

Document Information
 Transport Assessment

Baseline, Construction and
 Development case traffic flow
 (AM peak hour)

Figure 21.4.5
 1PL03-TT-50905
 January 2013

Site: KEMP
 Borough: Tower Hamlets
 Junction: The Highway/ Glamis Rd
 Junction no.: PBA 28

Key

Baseline
Construction Base
Development Case

Data: Traffic Flow in PCUs - PM Peak Hour
 from Traffic Survey

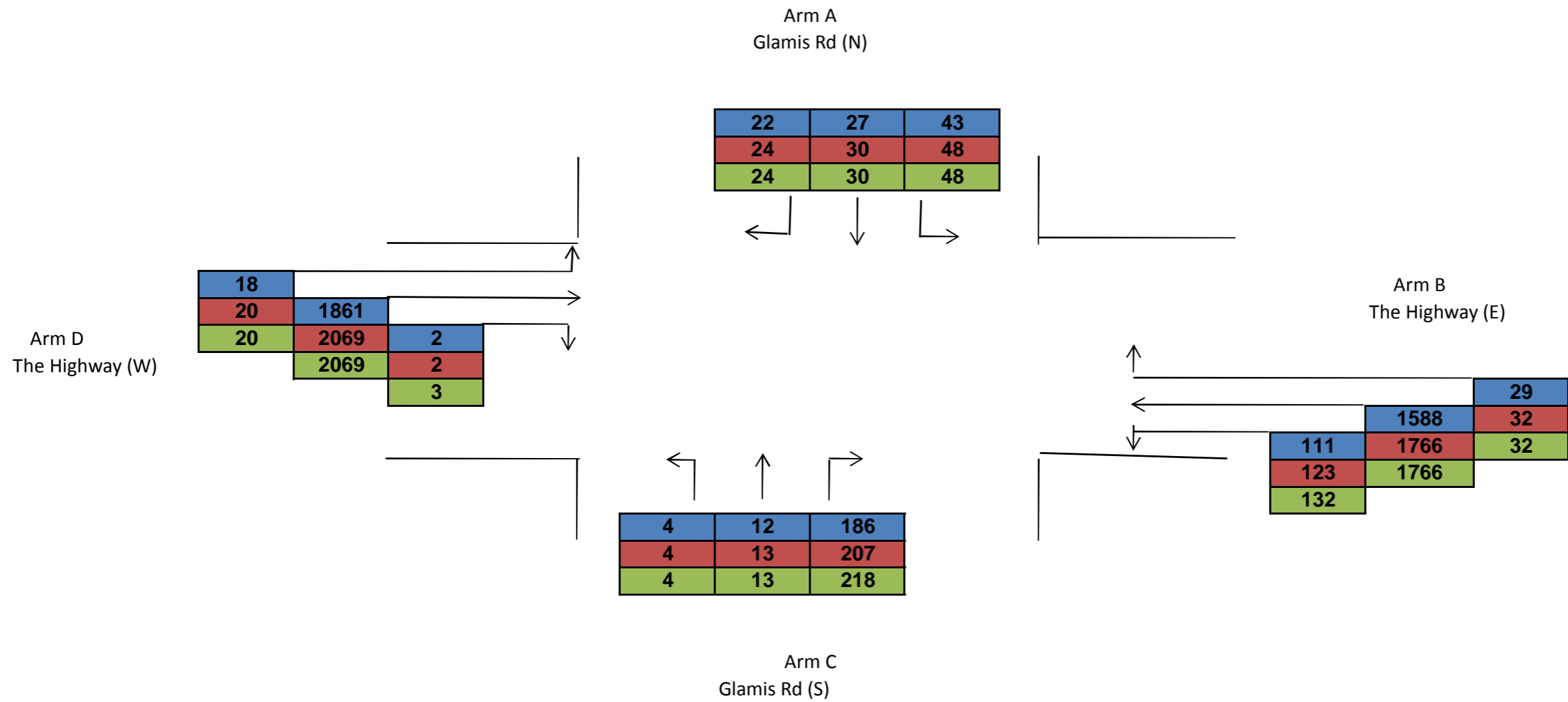

FOR INFORMATION

Location
 King Edward Memorial Park
 London Borough of Tower Hamlets

Document Information
 Transport Assessment

Baseline, Construction and
 Development case traffic flow
 (PM peak hour)

Figure 21.4.6
 1PL03-TT-50929
 January 2013



- Key**
- Slight
 - Serious
 - Fatal
 - Limits of Land to be Acquired or Used
 - Local authority boundary



Scale 1 : 7,500 at A3

FOR INFORMATION

Location
King Edward Memorial Park Foreshore
 London Borough of Tower Hamlets

Document Information
Transport Assessment
 Transport - accident locations

Figure 21.4.7
 1PL03-TT-50750
 January 2013



Mapping reproduced by permission of Ordnance Survey on behalf of HMSO. © Crown Copyright and Database right 2012. All rights reserved. Ordnance Survey licence number 100019345



- Key**
- Accidents**
(Severity, Mode of travel)
- Slight, Pedestrian
 - Slight, Pedal Cycle
 - Serious, Pedestrian
- Limits of Land to be Acquired or Used
- Local authority boundary

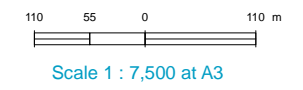

FOR INFORMATION

Location
King Edward Memorial Park Foreshore
London Borough of Tower Hamlets

Document Information
Transport Assessment
Transport - pedestrian and cyclist accidents by severity
Figure 21.4.8
1PL03-TT-50834
January 2013

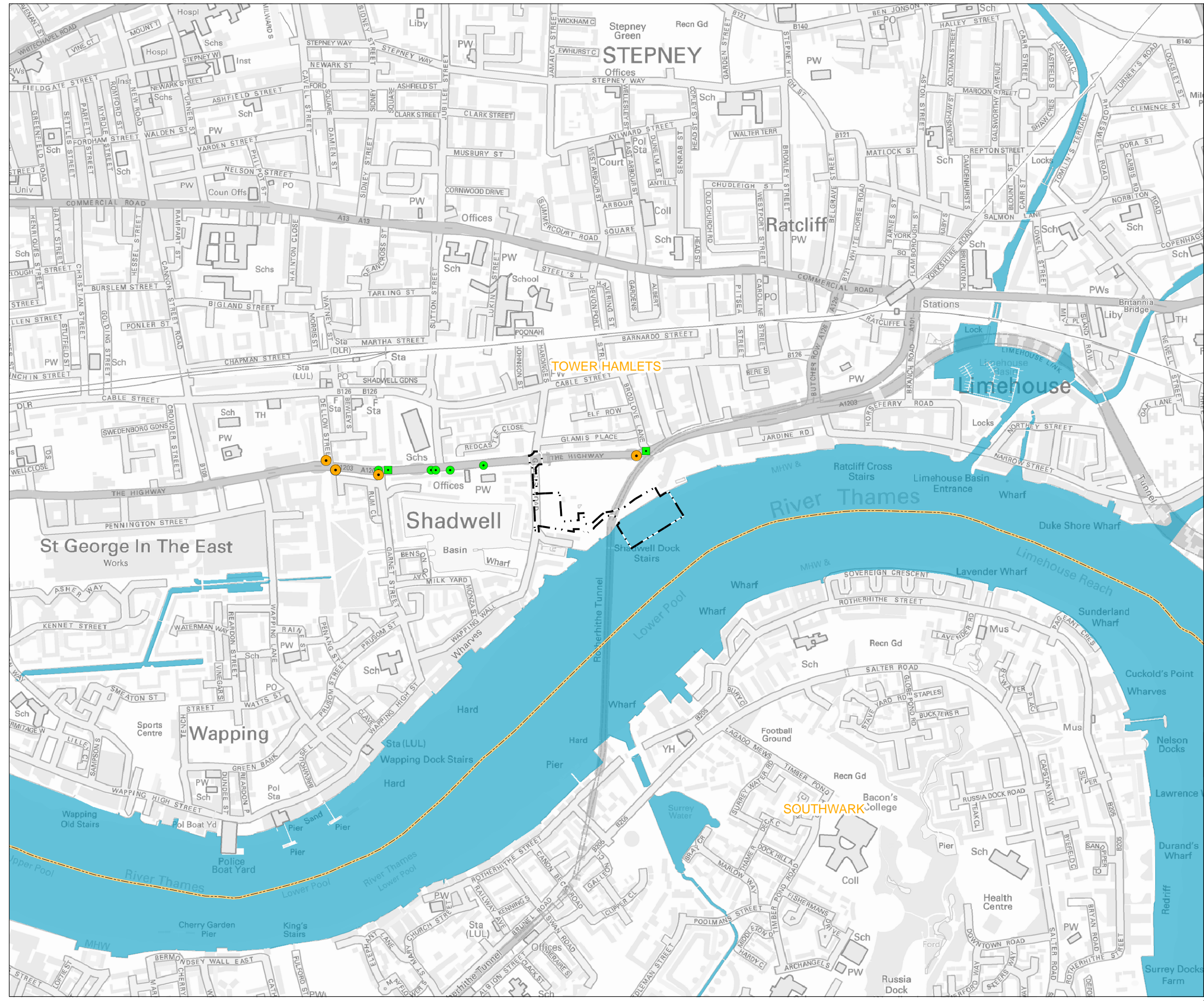

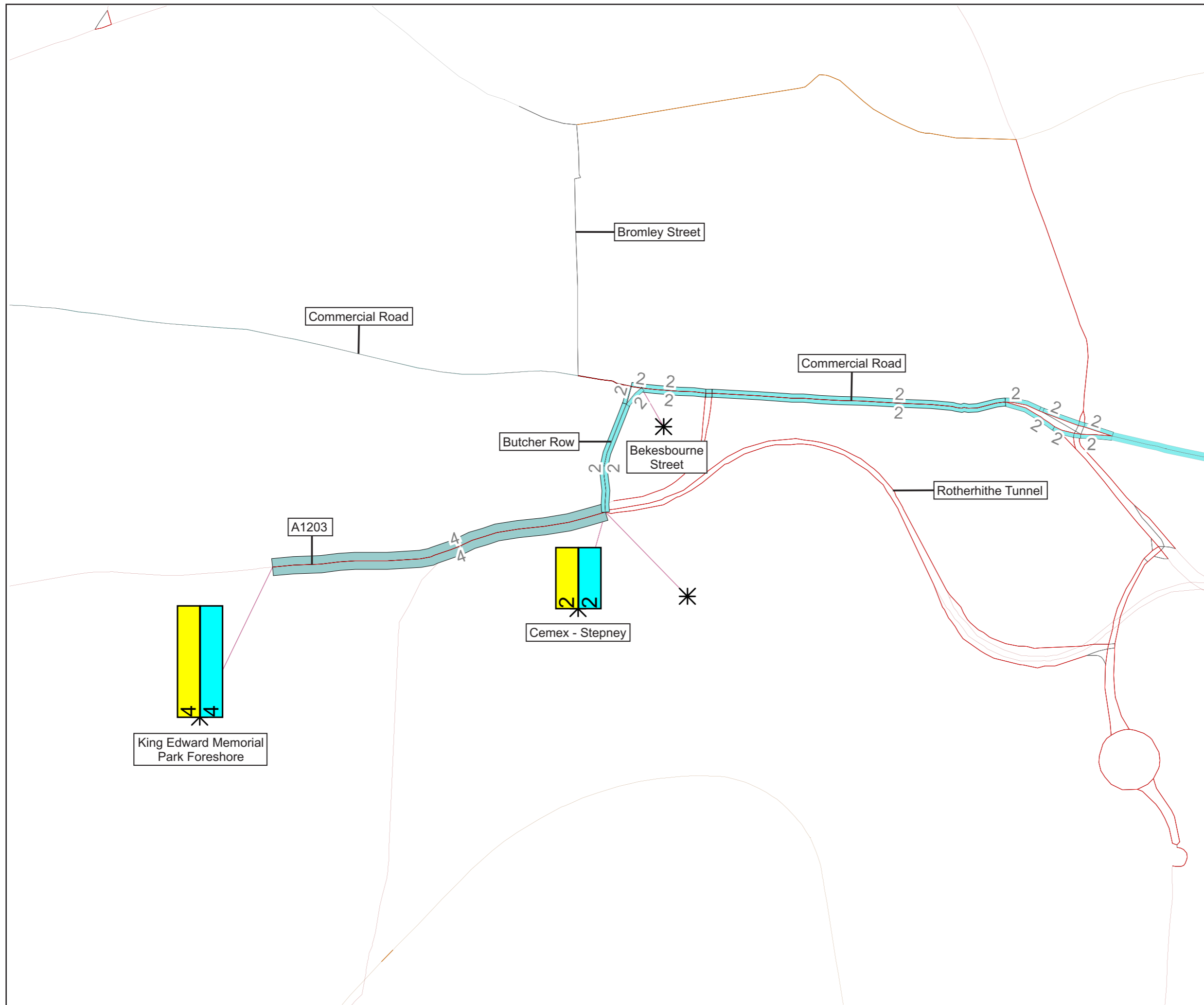

Hourly construction lorries arrivals and departures

- Arrivals
- Departures

Hourly construction lorries movements

- 0 - 1
- 1 - 2
- 2 - 3
- 3 - 4
- 4 - 5
- 5 - 6
- 6 - 7
- 7 - 8
- 8 - 9
- 9 - 10
- 10 - 11
- 11 - 12
- 12 - 13
- 13 - 14
- 14 - 15
- > 15

Note: Construction vehicle flows include all Thames Tideway Tunnel sites on this network during this period.

FOR INFORMATION

Location
King Edward Memorial Park Foreshore
 London Borough of Tower Hamlets

Document Information
Transport Assessment
 Hourly Construction Lorry Movements -
 Site Year 1 of Construction

Figure 21.5.1
 1PL03-TT-50897



This page is intentionally left blank

This page is intentionally blank

Copyright notice

Copyright © Thames Water Utilities Limited January 2013.
All rights reserved.

Any plans, drawings, designs and materials (materials) submitted by Thames Water Utilities Limited (Thames Water) as part of this application for Development Consent to the Planning Inspectorate are protected by copyright. You may only use this material (including making copies of it) in order to (a) inspect those plans, drawings, designs and materials at a more convenient time or place; or (b) to facilitate the exercise of a right to participate in the pre-examination or examination stages of the application which is available under the Planning Act 2008 and related regulations. Use for any other purpose is prohibited and further copies must not be made without the prior written consent of Thames Water.

Thames Water Utilities Limited

Clearwater Court, Vastern Road, Reading RG1 8DB

The Thames Water logo and Thames Tideway Tunnel logo are © Thames Water Utilities Limited. All rights reserved.

DCO-DT-000-ZZZZZ-071018

